

powermax600[®]

Plasma Arc Cutting System

***Operator Manual
803390 Revision 2***

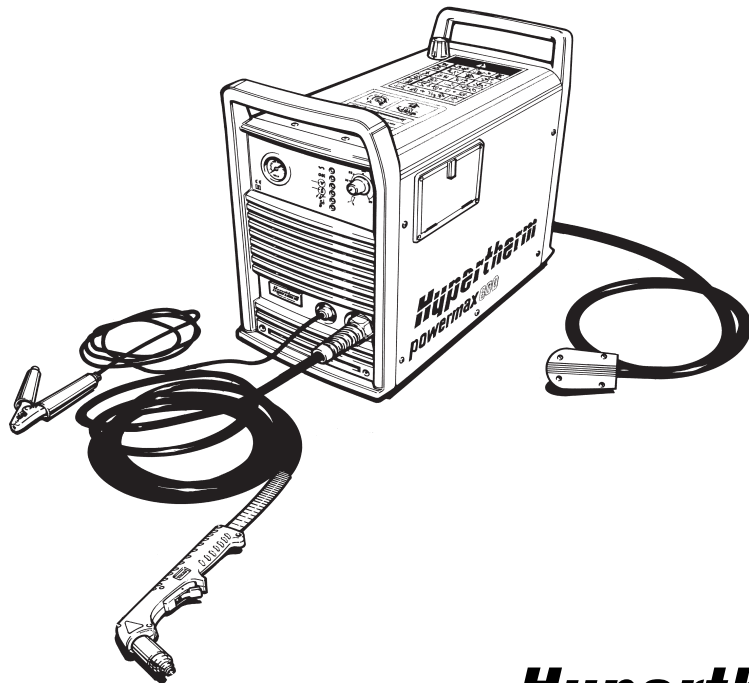

Hypertherm
*The world leader in
plasma cutting technology*

powermax600

Operator Manual IM-339 (P/N 803390)

Revision 2 October 1999

**Hypertherm, Inc.
Hanover, NH USA
<http://www.hypertherm.com>
[email:info@hypertherm.com](mailto:info@hypertherm.com)**

© Copyright 1999 Hypertherm, Inc.
All Rights Reserved

Hypertherm and powermax are trademarks of Hypertherm, Inc.
and may be registered in the United States and/or other countries.

Hypertherm, Inc.

Etna Road, P.O. Box 5010
Hanover, NH 03755 USA
603-643-3441 Tel (Main Office)
603-643-5352 Fax (All Departments)
800-643-9878 Tel (Technical Service)
800-737-2978 Tel (Customer Service)

Hypertherm Automation, LLC

5 Technology Drive
West Lebanon, NH 03755 USA
603-298-7970 Tel
603-298-7977 Fax

Hypertherm Plasmatechnik, GmbH

Technologiepark Hanau
Rodenbacher Chaussee 6
63457 Hanau-Wolfgang, Deutschland
49 6181 58 2100 Tel
49 6181 58 2134 Fax
49 6181 58 2123 (Technical Service)

Hypertherm (S) Pte Ltd

No. 19 Kaki Bukit Road 2
K.B. Warehouse Complex
Singapore 417847, Republic of Singapore
65 6 841 2489 Tel
65 6 841 2490 Fax
65 6 841 2489 (Technical Service)

Japan

1952-14 Yata-Natsumegi
Mishima City, Shizuoka Pref.
411-0801 Japan
81 0 559 75 7387 Tel
81 0 559 75 7376 Fax

Hypertherm UK, Ltd

9 Berkeley Court, Manor Park
Runcorn, Cheshire, England WA7 1TQ
44 1928 579 074 Tel
44 1928 579 604 Fax

France

15 Impasse des Rosiers
95610 Eragny, France
00 800 3324 9737 Tel
00 800 4973 7329 Fax

Hypertherm S.r.l.

Via Torino 2
20123 Milano, Italia
39 02 725 46 312 Tel
39 02 725 46 400 Fax
39 02 725 46 314 (Technical Service)

Hypertherm Europe B.V.

Vaartveld 9
4704 SE Roosendaal, Nederland
31 165 596908 Tel
31 165 596901 Fax

Technical Service:

00 800 49 73 7843 – toll-free in Europe
31 165 596900 Tel

Hypertherm Brasil Ltda.

Rua Visconde de Santa Isabel, 20 – Sala 611
Vila Isabel, RJ
Brasil CEP 20560-120
55 21 2278 6162 Tel
55 21 2578 0947 Fax

EMC INTRODUCTION

Hypertherm's CE-marked equipment is built in compliance with standard EN50199. The equipment should be installed and used in accordance with the information below to achieve electromagnetic compatibility.

The limits required by EN50199 may not be adequate to completely eliminate interference when the affected equipment is in close proximity or has a high degree of sensitivity. In such cases it may be necessary to use other measures to further reduce interference.

This plasma equipment is designed for use only in an industrial environment.

INSTALLATION AND USE

The user is responsible for installing and using the plasma equipment according to the manufacturer's instructions. If electromagnetic disturbances are detected then it shall be the responsibility of the user to resolve the situation with the technical assistance of the manufacturer. In some cases this remedial action may be as simple as earthing the cutting circuit, see *Earthing of Workpiece*. In other cases it could involve constructing an electromagnetic screen enclosing the power source and the work complete with associated input filters. In all cases electromagnetic disturbances must be reduced to the point where they are no longer troublesome.

ASSESSMENT OF AREA

Before installing the equipment the user shall make an assessment of potential electromagnetic problems in the surrounding area. The following shall be taken into account:

- a. Other supply cables, control cables, signalling and telephone cables; above, below and adjacent to the cutting equipment.
- b. Radio and television transmitters and receivers.
- c. Computer and other control equipment.
- d. Safety critical equipment, for example guarding of industrial equipment.
- e. Health of the people around, for example the use of pacemakers and hearing aids.
- f. Equipment used for calibration or measurement.
- g. Immunity of other equipment in the environment. User shall ensure that other equipment being used in the environment is compatible. This may require additional protection measures.
- h. Time of day that cutting or other activities are to be carried out.

The size of the surrounding area to be considered will depend on the structure of the building and other activities that are taking place. The surrounding area may extend beyond the boundaries of the premises.

METHODS OF REDUCING EMISSIONS

Mains Supply

Cutting equipment must be connected to the mains supply according to the manufacturer's recommendations. If interference occurs, it may be necessary to take additional precautions such as filtering of the mains supply. Consideration should be given to shielding the supply cable of permanently installed cutting equipment, in metallic conduit or equivalent. Shielding should be electrically continuous throughout its length. The shielding should be connected to the cutting mains supply so that good electrical contact is maintained between the conduit and the cutting power source enclosure

Maintenance of Cutting Equipment

The cutting equipment must be routinely maintained according to the manufacturer's recommendations. All access and service doors and covers should be closed and properly fastened when the cutting equipment is in operation. The cutting equipment should not be modified in any way except for those changes and adjustments covered in the manufacturer's instructions. In particular, the spark gaps of arc striking and stabilizing devices should be adjusted and maintained according to the manufacturer's recommendations.

Cutting Cables

The cutting cables should be kept as short as possible and should be positioned close together, running at or close to the floor level.

Equipotential Bonding

Bonding of all metallic components in the cutting installation and adjacent to it should be considered. However, metallic components bonded to the workpiece will increase the risk that the operator could receive a shock by touching these metallic components and the electrode at the same time. The operator should be insulated from all such bonded metallic components.

Earthing of Workpiece

Where the workpiece is not bonded to earth for electrical safety, nor connected to earth because of its size and position, for example, ship's hull or building steelwork, a connection bonding the workpiece to earth may reduce emissions in some, but not all instances. Care should be taken to prevent the earthing of the workpiece increasing the risk of injury to users, or damage to other electrical equipment. Where necessary, the connection of the workpiece to earth should be made by a direct connection to the workpiece, but in some countries where direct connection is not permitted, the bonding should be achieved by suitable capacitances selected according to national regulations.

Note. The cutting circuit may or may not be earthed for safety reasons. Changing the earthing arrangements should only be authorized by a person who is competent to assess whether the changes will increase the risk of injury, for example, by allowing parallel cutting current return paths which may damage the earth circuits of other equipment. Further guidance is given in IEC TC26 (sec)94 and IEC TC26/108A/CD Arc Welding Equipment Installation and Use.

Screening and Shielding

Selective screening and shielding of other cables and equipment in the surrounding area may alleviate problems of interference. Screening of the entire plasma cutting installation may be considered for special applications

WARRANTY

WARNING

Genuine Hypertherm parts are the factory-recommended replacement parts for your Hypertherm system. Any damage caused by the use of other than genuine Hypertherm parts may not be covered by the Hypertherm warranty.

WARNING

You are responsible for the safe use of the Product. Hypertherm does not and cannot make any guarantee or warranty regarding the safe use of the Product in your environment.

GENERAL

Hypertherm, Inc. warrants that its Products shall be free from defects in materials and workmanship, if Hypertherm is notified of a defect (i) with respect to the power supply within a period of two (2) years from the date of its delivery to you, with the exception of G3 Series power supplies, which shall be within a period of three (3) years from the date of delivery to you, and (ii) with respect to the torch and leads within a period of one (1) year from its date of delivery to you. This warranty shall not apply to any Product which has been incorrectly installed, modified, or otherwise damaged. Hypertherm, at its sole option, shall repair, replace, or adjust, free of charge, any defective Products covered by this warranty which shall be returned with Hypertherm's prior authorization (which shall not be unreasonably withheld), properly packed, to Hypertherm's place of business in Hanover, New Hampshire, or to an authorized Hypertherm repair facility, all costs, insurance and freight prepaid. Hypertherm shall not be liable for any repairs, replacement, or adjustments of Products covered by this warranty, except those made pursuant to this paragraph or with Hypertherm's prior written consent. **The warranty above is exclusive and is in lieu of all other warranties, express, implied, statutory, or otherwise with respect to the Products or as to the results which may be obtained therefrom, and all implied warranties or conditions of quality or of merchantability or fitness for a particular purpose or against infringement. The foregoing shall constitute the sole and exclusive remedy for any breach by Hypertherm of its warranty.** Distributors/OEMs may offer different or additional warranties, but Distributors/OEMs are not authorized to give any additional warranty protection to you or make any representation to you purporting to be binding upon Hypertherm.

PATENT INDEMNITY

Except only in cases of products not manufactured by Hypertherm or manufactured by a person other than Hypertherm not in strict conformity with Hypertherm's specifications and in cases of designs, processes, formulae, or combinations not developed or purported to be developed by Hypertherm, Hypertherm will defend or settle, at its own expense, any suit or proceeding brought against you alleging that the use of the Hypertherm product, alone and not in combination with any other product not supplied by

Hypertherm, infringes any patent of any third party. You shall notify Hypertherm promptly upon learning of any action or threatened action in connection with any such alleged infringement, and Hypertherm's obligation to indemnify shall be conditioned upon Hypertherm's sole control of, and the indemnified party's cooperation and assistance in, the defense of the claim.

LIMITATION OF LIABILITY

In no event shall Hypertherm be liable to any person or entity for any incidental, consequential, indirect, or punitive damages (including but not limited to lost profits) regardless of whether such liability is based on breach of contract, tort, strict liability, breach of warranties, failure of essential purpose or otherwise and even if advised of the possibility of such damages.

LIABILITY CAP

In no event shall Hypertherm's liability, whether such liability is based on breach of contract, tort, strict liability, breach of warranties, failure of essential purpose or otherwise, for any claim action suit or proceeding arising out of or relating to the use of the Products exceed in the aggregate the amount paid for the Products that gave rise to such claim.

INSURANCE

At all times you will have and maintain insurance in such quantities and types, and with coverage sufficient and appropriate to defend and to hold Hypertherm harmless in the event of any cause of action arising from the use of the Products.

NATIONAL AND LOCAL CODES

National and Local codes governing plumbing and electrical installation shall take precedent over any instructions contained in this manual. **In no event** shall Hypertherm be liable for injury to persons or property damage by reason of any code violation or poor work practices.

TRANSFER OF RIGHTS

You may transfer any remaining rights you may have hereunder only in connection with the sale of all or substantially all of your assets or capital stock to a successor in interest who agrees to be bound by all of the terms and conditions of this Warranty.

ELECTROMAGNETIC COMPATIBILITYi
WARRANTYii

Section 1 Safety

Recognize safety information.....1-2
Follow safety instructions.....1-2
Cutting can cause fire or explosion.....1-2
Electric shock can kill.....1-3
Cutting can produce toxic fumes1-3
Plasma arc can cause injury and burns.....1-4
Arc rays can burn eyes and skin.....1-4
Grounding safety1-4
Compressed gas equipment safety1-5
Gas cylinders can exploded if damaged.....1-5
Noise can damage hearing.....1-5
Pacemaker and hearing aid operation.....1-5
Additional safety information.....1-5
Warning label1-6

Section 1a Sécurité

Identifier les consignes de sécurité.....1a-2
Suivre les instructions de sécurité1a-2
Le coupage peut provoquer un incendie ou une explosion1a-2
Les chocs électriques peuvent être fatals.....1a-3
Le coupage peut produire des vapeurs toxiques1a-3
L'arc plasma peut provoquer des blessures ou des brûlures1a-4
Mise à la masse et à la terre.....1a-4
Les rayons de l'arc peuvent brûler les yeux et la peau.....1a-4
Sécurité des bouteilles de gaz comprimé1a-5
Les bouteilles de gaz comprimé peuvent exploser en cas de dommages1a-5
Le bruit peut provoquer des problèmes auditifs.....1a-5
Pacemakers et prothèses auditives.....1a-5
Étiquette de sécurité1a-6

Section 2 Specifications

Specifications, power supply2-2
Specifications, PAC123 torches.....2-3
Symbols and markings2-4

Section 3 Setup

Lifting power supply3-2
Power hookup.....3-3
Torch hookup (208-240/480 volt only)3-5
Gas hookup3-6
PAC123 machine torch hookup3-7

TABLE OF CONTENTS

Section 4 Operation

Controls and Indicators	4-2
Confirm torch consumables	4-3
Installing torch consumables	4-4
Pilot arc control switch (208-240/480 volt only)	4-5
Turn on power	4-5
Check indicator lights	4-5
Adjust gas pressure and current setting	4-6
Hand torch operation	4-7
Machine torch operation	4-12
Cut chart	4-12

Section 5 Maintenance/Parts

Routine maintenance	5-2
Inspect consumables	5-3
Torch lead replacement	5-5
Work cable replacement	5-6
Power cord replacement	5-7
Air filter element replacment	5-8
Basic Troubleshooting	5-10
Technical Questions	5-10
Parts	5-14
Torch consumables	See Section 4
PAC123T hand torch assembly (No Q-disc.)	5-14
PAC123T hand torch assembly (With Q-disc.)	5-16
PAC123M machine torch assembly (No Q-disc.)	5-18
PAC123M machine torch assembly (With Q-disc.)	5-20
Power supply - filter regulator	5-22
Power supply - work cable	5-22
Power max600 labels	5-23
Power,max600 field upgrade kits and optional parts	5-23

Section 1

SAFETY

In this section:

Recognize Safety Information	1-2
Follow Safety Instructions	1-2
Cutting Can Cause Fire or Explosion	1-2
Electric Shock Can Kill	1-3
Cutting Can Produce Toxic Fumes	1-3
A Plasma Arc Can Cause Injury and Burns	1-4
Arc Rays Can Burn Eyes and Skin	1-4
Grounding Safety	1-4
Compressed Gas Equipment Safety	1-5
Gas Cylinders Can Explode If Damaged	1-5
Noise Can Damage Hearing	1-5
Pacemaker and Hearing Aid Operation	1-5
A Plasma Arc Can Damage Frozen Pipes	1-5
Additional Safety Information	1-5
Warning Label	1-6



RECOGNIZE SAFETY INFORMATION

The symbols shown in this section are used to identify potential hazards. When you see a safety symbol in this manual or on your machine, understand the potential for personal injury, and follow the related instructions to avoid the hazard.



FOLLOW SAFETY INSTRUCTIONS

Read carefully all safety messages in this manual and safety labels on your machine.

- Keep the safety labels on your machine in good condition. Replace missing or damaged labels immediately.
- Learn how to operate the machine and how to use the controls properly. Do not let anyone operate it without instruction.

- Keep your machine in proper working condition. Unauthorized modifications to the machine may affect safety and machine service life.

DANGER WARNING CAUTION

A signal word DANGER or WARNING is used with a safety symbol. DANGER identifies the most serious hazards.

- DANGER and WARNING safety labels are located on your machine near specific hazards.
- WARNING safety messages precede related instructions in this manual that may result in injury or death if not followed correctly.
- CAUTION safety messages precede related instructions in this manual that may result in damage to equipment if not followed correctly.



CUTTING CAN CAUSE FIRE OR EXPLOSION

Fire Prevention

- Be sure the area is safe before doing any cutting. Keep a fire extinguisher nearby.
- Remove all flammables within 35 feet (10 m) of the cutting area.
- Quench hot metal or allow it to cool before handling or before letting it touch combustible materials.
- Never cut containers with potentially flammable materials inside – they must be emptied and properly cleaned first.
- Ventilate potentially flammable atmospheres before cutting.
- When cutting with oxygen as the plasma gas, an exhaust ventilation system is required.

Explosion Prevention

- Do not use the plasma system if explosive dust or vapors may be present.
- Do not cut pressurized cylinders, pipes, or any closed container.
- Do not cut containers that have held combustible materials.



WARNING

Explosion Hazard
Argon-Hydrogen and Methane

Hydrogen and methane are flammable gases that present an explosion hazard. Keep flames away from cylinders and hoses that contain methane or hydrogen mixtures. Keep flames and sparks away from the torch when using methane or argon-hydrogen plasma.



WARNING

Hydrogen Detonation with
Aluminum Cutting

- When cutting aluminum underwater, or with the water touching the underside of the aluminum, free hydrogen gas may collect under the workpiece and detonate during plasma cutting operations.
- Install an aeration manifold on the floor of the water table to eliminate the possibility of hydrogen detonation. Refer to the Appendix section of this manual for aeration manifold details.



ELECTRIC SHOCK CAN KILL

Touching live electrical parts can cause a fatal shock or severe burn.

- Operating the plasma system completes an electrical circuit between the torch and the workpiece. The workpiece and anything touching the workpiece are part of the electrical circuit.
- Never touch the torch body, workpiece or the water in a water table when the plasma system is operating.

Electric Shock Prevention

All Hypertherm plasma systems use high voltage in the cutting process (200 to 400 VDC are common). Take the following precautions when operating this system:

- Wear insulated gloves and boots, and keep your body and clothing dry.
- Do not stand, sit or lie on – or touch – any wet surface when using the plasma system.
- Insulate yourself from work and ground using dry insulating mats or covers big enough to prevent any physical contact with the work or ground. If you must work in or near a damp area, use extreme caution.
- Provide a disconnect switch close to the power supply with properly sized fuses. This switch allows the operator to turn off the power supply quickly in an emergency situation.
- When using a water table, be sure that it is correctly connected to earth ground.

- Install and ground this equipment according to the instruction manual and in accordance with national and local codes.
- Inspect the input power cord frequently for damage or cracking of the cover. Replace a damaged power cord immediately. **Bare wiring can kill.**
- Inspect and replace any worn or damaged torch leads.
- Do not pick up the workpiece, including the waste cutoff, while you cut. Leave the workpiece in place or on the workbench with the work cable attached during the cutting process.
- Before checking, cleaning or changing torch parts, disconnect the main power or unplug the power supply.
- Never bypass or shortcut the safety interlocks.
- Before removing any power supply or system enclosure cover, disconnect electrical input power. Wait 5 minutes after disconnecting the main power to allow capacitors to discharge.
- Never operate the plasma system unless the power supply covers are in place. Exposed power supply connections present a severe electrical hazard.
- When making input connections, attach proper grounding conductor first.
- Each Hypertherm plasma system is designed to be used only with specific Hypertherm torches. Do not substitute other torches which could overheat and present a safety hazard.



CUTTING CAN PRODUCE TOXIC FUMES

Cutting can produce toxic fumes and gases that deplete oxygen and cause injury or death.

- Keep the cutting area well ventilated or use an approved air-supplied respirator.
- Do not cut in locations near degreasing, cleaning or spraying operations. The vapors from certain chlorinated solvents decompose to form phosgene gas when exposed to ultraviolet radiation.
- Do not cut metal coated or containing toxic materials, such as zinc (galvanized), lead, cadmium or beryllium, unless the area is well ventilated and the operator wears an air-supplied respirator. The coatings and any metals containing these elements can produce toxic fumes when cut.
- Never cut containers with potentially toxic materials inside – they must be emptied and properly cleaned first.
- This product, when used for welding or cutting, produces fumes or gases which contain chemicals known to the State of California to cause birth defects and, in some cases, cancer.



A PLASMA ARC CAN CAUSE INJURY AND BURNS

Instant-On Torches

Plasma arc comes on immediately when the torch switch is activated.

The plasma arc will cut quickly through gloves and skin.

- Keep away from the torch tip.
- Do not hold metal near the cutting path.
- Never point the torch toward yourself or others.



ARC RAYS CAN BURN EYES AND SKIN

Eye Protection Plasma arc rays produce intense visible and invisible (ultraviolet and infrared) rays that can burn eyes and skin.

- Use eye protection in accordance with applicable national or local codes.
- Wear eye protection (safety glasses or goggles with side shields, and a welding helmet) with appropriate lens shading to protect your eyes from the arc's ultraviolet and infrared rays.

Skin Protection Wear protective clothing to protect against burns caused by ultraviolet light, sparks and hot metal.

- Gauntlet gloves, safety shoes and hat.
- Flame-retardant clothing to cover all exposed areas.
- Cuffless trousers to prevent entry of sparks and slag.
- Remove any combustibles, such as a butane lighter or matches, from your pockets before cutting.

Arc Current
Up to 100 A
100-200 A
200-400 A
Over 400 A



Lens Shade	
AWS (USA)	ISO 4850
No. 8	No. 11
No. 10	No. 11-12
No. 12	No. 13
No. 14	No. 14

Cutting Area Prepare the cutting area to reduce reflection and transmission of ultraviolet light:

- Paint walls and other surfaces with dark colors to reduce reflection.
- Use protective screens or barriers to protect others from flash and glare.
- Warn others not to watch the arc. Use placards or signs.



GROUNDING SAFETY

Work Cable Attach the work cable securely to the workpiece or the work table with good metal-to-metal contact. Do not connect it to the piece that will fall away when the cut is complete.

Work Table Connect the work table to an earth ground, in accordance with appropriate national or local electrical codes.

Input Power

- Be sure to connect the power cord ground wire to the ground in the disconnect box.
- If installation of the plasma system involves connecting the power cord to the power supply, be sure to connect the power cord ground wire properly.
- Place the power cord's ground wire on the stud first, then place any other ground wires on top of the power cord ground. Fasten the retaining nut tightly.
- Tighten all electrical connections to avoid excessive heating.

COMPRESSED GAS EQUIPMENT SAFETY

- Never lubricate cylinder valves or regulators with oil or grease.
- Use only correct gas cylinders, regulators, hoses and fittings designed for the specific application.
- Maintain all compressed gas equipment and associated parts in good condition.
- Label and color-code all gas hoses to identify the type of gas in each hose. Consult applicable national or local codes.

**GAS CYLINDERS CAN EXPLODE IF DAMAGED**

Gas cylinders contain gas under high pressure. If damaged, a cylinder can explode.

- Handle and use compressed gas cylinders in accordance with applicable national or local codes.
- Never use a cylinder that is not upright and secured in place.
- Keep the protective cap in place over valve except when the cylinder is in use or connected for use.
- Never allow electrical contact between the plasma arc and a cylinder.
- Never expose cylinders to excessive heat, sparks, slag or open flame.
- Never use a hammer, wrench or other tool to open a stuck cylinder valve.

**NOISE CAN DAMAGE HEARING**

Prolonged exposure to noise from cutting or gouging can damage hearing.

- Use approved ear protection when using plasma system.
- Warn others nearby about the noise hazard.

**PACEMAKER AND HEARING AID OPERATION**

Pacemaker and hearing aid operation can be affected by magnetic fields from high currents. Pacemaker and hearing aid wearers should consult a doctor before going near any plasma arc cutting and gouging operations.

To reduce magnetic field hazards:

- Keep both the work cable and the torch lead to one side, away from your body.
- Route the torch leads as close as possible to the work cable.
- Do not wrap or drape the torch lead or work cable around your body.
- Keep as far away from the power supply as possible.

**A PLASMA ARC CAN DAMAGE FROZEN PIPES**

Frozen pipes may be damaged or can burst if you attempt to thaw them with a plasma torch.

ADDITIONAL SAFETY INFORMATION

1. ANSI Standard Z49.1, *Safety in Welding and Cutting*, American Welding Society, 550 LeJeune Road P.O. Box 351020, Miami, FL 33135
2. ANSI Standard Z49.2, *Fire Prevention in the Use of Cutting and Welding Processes*, American National Standards Institute 1430 Broadway, New York, NY 10018
3. ANSI Standard Z87.1, *Safe Practices for Occupation and Educational Eye and Face Protection*, American National Standards Institute, 1430 Broadway, New York, NY 10018
4. AWS F4.1, *Recommended Safe Practices for the Preparation for Welding and Cutting of Containers and Piping That Have Held Hazardous Substances*, American Welding Society 550 LeJeune Road, P.O. Box 351040, Miami, FL 33135
5. AWS F5.2, *Recommended Safe Practices for Plasma Arc Cutting*, American Welding Society 550 LeJeune Road, P.O. Box 351040, Miami, FL 33135
6. CGA Pamphlet P-1, *Safe Handling of Compressed Gases in Cylinders*, Compressed Gas Association 1235 Jefferson Davis Highway, Arlington, VA 22202
7. CSA Standard W117.2, *Code for Safety in Welding and Cutting*, Canadian Standards Association Standard Sales 178 Rexdale Boulevard, Rexdale, Ontario M9W 1R3, Canada
8. NFPA Standard 51B, *Cutting and Welding Processes*, National Fire Protection Association 470 Atlantic Avenue, Boston, MA 02210
9. NFPA Standard 70-1978, *National Electrical Code*, National Fire Protection Association, 470 Atlantic Avenue, Boston, MA 02210
10. OSHA, *Safety and Health Standards*, 29FR 1910 U.S. Government Printing Office, Washington, D.C. 20402

WARNING LABEL

This warning label is affixed to some power supplies. It is important that the operator and maintenance technician understand the intent of these warning symbols as described. The numbered text corresponds to the numbered boxes on the label.



1. Cutting sparks can cause explosion or fire.
 - 1.1 Keep flammables away from cutting.
 - 1.2 Keep a fire extinguisher nearby, and have a watchperson ready to use it.
 - 1.3 Do not cut on any closed containers.
2. The plasma arc can cause injury and burns.
 - 2.1 Turn off power before disassembling torch.
 - 2.2 Do not hold the material near cutting path.
 - 2.3 Wear complete body protection.
3. Electric shock from torch or wiring can kill. Protect yourself from electric shock.
 - 3.1 Wear insulating gloves. Do not wear wet or damaged gloves.
 - 3.2 Insulate yourself from work and ground.
 - 3.3 Disconnect input plug or power before working on machine.
4. Breathing cutting fumes can be hazardous to your health.
 - 4.1 Keep your head out of the fumes.
 - 4.2 Use forced ventilation or local exhaust to remove the fumes.
 - 4.3 Use ventilating fan to remove the fumes.
5. Arc rays can burn eyes and injure skin.
 - 5.1 Wear hat and safety glasses. Use ear protection and button shirt collar. Use welding helmet with correct shade of filter. Wear complete body protection.
6. Become trained and read the instructions before working on the machine or cutting.
7. Do not remove or paint over (cover) warning labels.

Dans cette section :

Identifier les consignes de sécurité	1a-2
Suivre les instructions de sécurité.....	1a-2
Danger Avertissement Précaution.....	1a-2
Le coupage peut provoquer un incendie ou une explosion.....	1a-2
Prévention des incendies, Prévention des explosions	1a-2
Risque d'explosion argon-hydrogène et méthane	1a-2
Détonation de l'hydrogène lors du coupage de l'aluminium	1a-2
Les chocs électriques peuvent être fatals	1a-3
Prévention des chocs électriques	1a-3
Le coupage peut produire des vapeurs toxiques	1a-3
L'arc plasma peut provoquer des blessures ou des brûlures.....	1a-4
Torches à allumage instantané.....	1a-4
Les rayons de l'arc peuvent brûler les yeux et la peau	1a-4
Protection des yeux, Protection de la peau, Zone de coupage	1a-4
Mise à la masse et à la terre	1a-4
Câble de retour, Table de travail, Alimentation	1a-4
Sécurité des bouteilles de gaz comprimé	1a-5
Les bouteilles de gaz comprimé peuvent exploser en cas de dommages.....	1a-5
Le bruit peut provoquer des problèmes auditifs	1a-5
Pacemakers et prothèses auditives	1a-5
Un arc plasma peut endommager les tuyaux gelés	1a-5
Étiquette de sécurité	1a-6



IDENTIFIER LES CONSIGNES DE SÉCURITÉ

Les symboles indiqués dans cette section sont utilisés pour identifier les risques éventuels. Si vous trouvez un symbole de sécurité, que ce soit dans ce manuel ou sur l'équipement, soyez conscient des risques de blessures et suivez les instructions correspondantes afin d'éviter ces risques.



SUIVRE LES INSTRUCTIONS DE SÉCURITÉ

Lire attentivement toutes les consignes de sécurité dans le présent manuel et sur les étiquettes de sécurité se trouvant sur la machine.

- Les étiquettes de sécurité doivent rester lisibles. Remplacer immédiatement les étiquettes manquantes ou abîmées.
- Apprendre à faire fonctionner la machine et à utiliser correctement les commandes. Ne laisser personne utiliser la machine sans connaître son fonctionnement.

- Garder la machine en bon état. Des modifications non autorisées sur la machine peuvent engendrer des problèmes de sécurité et raccourcir la durée d'utilisation de l'équipement.

DANGER AVERTISSEMENT PRÉCAUTION

Les signaux DANGER ou AVERTISSEMENT sont utilisés avec un symbole de sécurité, DANGER correspondant aux risques les plus sérieux.

- Les étiquettes de sécurité DANGER et AVERTISSEMENT sont situées sur la machine pour signaler certains dangers spécifiques.
- Les messages d'AVERTISSEMENT précèdent les instructions d'utilisation expliquées dans ce manuel et signalent les risques de blessures ou de mort au cas où ces instructions ne seraient pas suivies correctement.
- Les messages de PRÉCAUTION précèdent les instructions d'utilisation contenues dans ce manuel et signalent que le matériel risque d'être endommagé si les instructions ne sont pas suivies correctement.



LE COUPAGE PEUT PROVOQUER UN INCENDIE OU UNE EXPLOSION

Prévention des incendies

- Avant de commencer, s'assurer que la zone de coupage ne présente aucun danger. Conserver un extincteur à proximité.
- Éloigner toute matière inflammable à une distance d'au moins 10 m du poste de coupage.
- Tremper le métal chaud ou le laisser refroidir avant de le manipuler ou avant de le mettre en contact avec des matériaux combustibles.
- Ne jamais couper des récipients pouvant contenir des matières inflammables avant de les avoir vidés et nettoyés correctement.
- Aérer toute atmosphère potentiellement inflammable avant d'utiliser un système plasma.
- Lors de l'utilisation d'oxygène comme gaz plasma, un système de ventilation par aspiration est nécessaire.

Prévention des explosions

- Ne pas couper en présence de poussière ou de vapeurs.
- Ne pas couper de bouteilles, de tuyaux ou autres récipients fermés et pressurisés.
- Ne pas couper de récipients contenant des matières combustibles.



AVERTISSEMENT

Risque d'explosion argon-hydrogène et méthane

L'hydrogène et le méthane sont des gaz inflammables et potentiellement explosifs. Conserver à l'écart de toute flamme les bouteilles et tuyaux contenant des mélanges à base d'hydrogène ou de méthane. Maintenir toute flamme et étincelle à l'écart de la torche lors de l'utilisation d'un plasma d'argon-hydrogène ou de méthane.



AVERTISSEMENT

Détonation de l'hydrogène lors du coupage de l'aluminium

- Lors du coupage de l'aluminium sous l'eau, ou si l'eau touche la partie inférieure de la pièce d'aluminium, de l'hydrogène libre peut s'accumuler sous la pièce à couper et détonner lors du coupage plasma.
- Installer un collecteur d'aération au fond de la table à eau afin d'éliminer les risques de détonation de l'hydrogène. Se référer à l'annexe du manuel pour plus de renseignements sur les collecteurs d'aération.



LES CHOCS ÉLECTRIQUES PEUVENT ÊTRE FATAUX

Toucher une pièce électrique sous tension peut provoquer un choc électrique fatal ou des brûlures graves.

- La mise en fonctionnement du système plasma ferme un circuit électrique entre la torche et la pièce à couper. La pièce à couper et tout autre élément en contact avec cette pièce font partie du circuit électrique.
- Ne jamais toucher le corps de la torche, la pièce à couper ou l'eau de la table à eau pendant le fonctionnement du système plasma.

Prévention des chocs électriques

Tous les systèmes plasma Hypertherm utilisent des hautes tensions pour le coupage (souvent de 200 à 400 V). On doit prendre les précautions suivantes quand on utilise le système plasma :

- Porter des bottes et des gants isolants et garder le corps et les vêtements au sec.
- Ne pas se tenir, s'asseoir ou se coucher sur une surface mouillée, ni la toucher quand on utilise le système plasma.
- S'isoler de la surface de travail et du sol en utilisant des tapis isolants secs ou des couvertures assez grandes pour éviter tout contact physique avec le travail ou le sol. S'il s'avère nécessaire de travailler dans ou près d'un endroit humide, procéder avec une extrême prudence.
- Installer un sectionneur avec fusibles appropriés, à proximité de la source de courant. Ce dispositif permet à l'opérateur d'arrêter rapidement la source de courant en cas d'urgence.
- En cas d'utilisation d'une table à eau, s'assurer que cette dernière est correctement mise à la terre.
- Installer et mettre à la terre l'équipement selon les instructions du présent manuel et conformément aux codes électriques locaux et nationaux.
- Inspecter fréquemment le cordon d'alimentation primaire pour s'assurer qu'il n'est ni endommagé, ni fendu. Remplacer immédiatement un cordon endommagé.
- **Un câble dénudé peut tuer.**
- Inspecter et remplacer les câbles de la torche qui sont usés ou endommagés.
- Ne pas saisir la pièce à couper ni les chutes lors du coupage. Laisser la pièce à couper en place ou sur la table de travail, le câble de retour connecté lors du coupage.
- Avant de vérifier, de nettoyer ou de remplacer les pièces de la torche, couper l'alimentation ou débrancher la prise de courant.
- Ne jamais contourner ou court-circuiter les verrouillages de sécurité.
- Avant d'enlever le capot du système ou de la source de courant, couper l'alimentation électrique. Attendre ensuite 5 minutes pour que les condensateurs se déchargent.
- Ne jamais faire fonctionner le système plasma sans que les capots de la source de courant ne soient en place. Les raccords exposés de la source de courant sont extrêmement dangereux.
- Lors de l'installation des connexions, attacher tout d'abord la prise de terre appropriée.
- Chaque système plasma Hypertherm est conçu pour être utilisé uniquement avec des torches Hypertherm spécifiques. Ne pas utiliser des torches inappropriées qui pourraient surchauffer et présenter des risques pour la sécurité.



LE COUPAGE PEUT PRODUIRE DES VAPEURS TOXIQUES

Le coupage peut produire des vapeurs et des gaz toxiques qui réduisent le niveau d'oxygène dans l'air et peuvent provoquer des blessures, voire la mort.

- Conserver le poste de coupage bien aéré ou utiliser un masque respiratoire homologué.
- Ne pas procéder au coupage près d'endroits où s'effectuent le dégraissage, le nettoyage ou la vaporisation. Certains solvants chlorés se décomposent sous l'effet des rayons ultraviolets et forment du phosgène.
- Ne pas couper des métaux peints ou contenant des matières toxiques comme le zinc (galvanisé), le plomb, le cadmium ou le béryllium, à moins que la zone de travail soit très bien ventilée et que l'opérateur porte un masque respiratoire. Les revêtements et métaux contenant ces matières peuvent produire des vapeurs toxiques lors du coupage.
- Ne jamais couper de récipients pouvant contenir des matières inflammables avant de les avoir vidés et nettoyés correctement.
- Quand on utilise ce produit pour le soudage ou le coupage, il dégage des fumées et des gaz qui contiennent des produits chimiques qui, selon l'État de Californie, provoquent des anomalies congénitales et, dans certains cas, le cancer.



L'ARC PLASMA PEUT PROVOQUER DES BLESSURES OU DES BRÛLURES

Torches à allumage instantané

L'arc plasma s'allume immédiatement après que la torche soit mise en marche.

L'arc plasma coupe facilement les gants et la peau.

- Rester éloigné de l'extrémité de la torche.
- Ne pas tenir de métal près de la trajectoire de coupe.
- Ne jamais pointer la torche vers soi ou d'autres personnes.



LES RAYONS DE L'ARC PEUVENT BRÛLER LES YEUX ET LA PEAU

Protection des yeux Les rayons de l'arc plasma produisent de puissants rayons visibles ou invisibles (ultraviolets et infrarouges) qui peuvent brûler les yeux et la peau.

- Utiliser des lunettes de sécurité conformément aux codes locaux ou nationaux en vigueur.
- Porter des lunettes de protection (lunettes ou masque muni d'écrans latéraux et encore masque de soudure) avec des verres teintés appropriés pour protéger les yeux des rayons ultraviolets et infrarouges de l'arc.

Protection de la peau Porter des vêtements de sécurité pour se protéger contre les brûlures que peuvent causer les rayons ultraviolets, les étincelles et le métal brûlant :

- Gants à crispin, chaussures et casque de sécurité.
- Vêtements ignifuges couvrant toutes les parties exposées du corps.
- Pantalon sans revers pour éviter que des étincelles ou des scories puissent s'y loger.
- Avant le coupage, retirer de ses poches tout objet combustible comme les briquets au butane ou les allumettes.

Courant de l'arc

Jusqu'à 100 A
100-200 A
200-400 A
Plus de 400 A



Puissance des verres teintés

AWS (É.-U.)

N° 8

N° 10

N° 12

N° 14

ISO 4850

N° 11

N° 11-12

N° 13

N° 14



Zone de coupage Préparer la zone de coupage afin de réduire la réverbération et la transmission de la lumière ultraviolette :

- Peindre les murs et autres surfaces de couleur sombre pour réduire la réflexion de la lumière.
- Utiliser des écrans et autres dispositifs de protection afin de protéger les autres personnes de la lumière et de la réverbération.
- Prévenir les autres personnes de ne pas regarder l'arc. Utiliser des affiches ou des panneaux.



MISE À LA MASSE ET À LA TERRE

Câble de retour Bien fixer le câble de retour (ou de masse) à la pièce à couper ou à la table de travail de façon à assurer un bon contact métal-métal. Ne pas fixer le câble de retour à la partie de la pièce qui doit se détacher.

Table de travail Raccorder la table de travail à la terre, conformément aux codes de sécurité locaux ou nationaux appropriés.

Alimentation

- S'assurer que le fil de terre du cordon d'alimentation est connecté à la terre dans le coffret du sectionneur.
- S'il est nécessaire de brancher le cordon d'alimentation à la source de courant lors de l'installation du système, s'assurer que le fil de terre est correctement branché.
- Placer tout d'abord le fil de terre du cordon d'alimentation sur le plot de mise à la terre puis placer les autres fils de terre par-dessus. Bien serrer l'écrou de retenue.
- S'assurer que toutes les connexions sont bien serrées pour éviter la surchauffe.

SÉCURITÉ DES BOUTEILLES DE GAZ COMPRIMÉ

- Ne jamais lubrifier les robinets des bouteilles ou les régulateurs avec de l'huile ou de la graisse.
- Utiliser uniquement les bouteilles, régulateurs, tuyaux et accessoires appropriés et conçus pour chaque application spécifique.
- Entretenir l'équipement et les pièces d'équipement à gaz comprimé afin de les garder en bon état.
- Étiqueter et coder avec des couleurs tous les tuyaux de gaz afin d'identifier le type de gaz contenu dans chaque tuyau. Se référer aux codes locaux ou nationaux en vigueur.



LES BOUTEILLES DE GAZ COMPRIMÉ PEUVENT EXPLOSER EN CAS DE DOMMAGES

Les bouteilles de gaz contiennent du gaz à haute pression. Si une bouteille est endommagée, elle peut exploser.

- Manipuler et utiliser les bouteilles de gaz comprimé conformément aux codes locaux ou nationaux.
- Ne jamais utiliser une bouteille qui n'est pas placée à la verticale et bien assujettie.
- Le capuchon de protection doit être placé sur le robinet sauf si la bouteille est en cours d'utilisation ou connectée pour utilisation.
- Éviter à tout prix le contact électrique entre l'arc plasma et une bouteille.
- Ne jamais exposer des bouteilles à une chaleur excessive, aux étincelles, aux scories ou aux flammes nues.
- Ne jamais utiliser des marteaux, des clés ou d'autres outils pour débloquer le robinet des bouteilles.



LE BRUIT PEUT PROVOQUER DES PROBLÈMES AUDITIFS

Une exposition prolongée au bruit du coupage ou du gougeage peut provoquer des problèmes auditifs.

- Utiliser un casque de protection homologué lors de l'utilisation du système plasma.
- Prévenir les personnes aux alentours des risques encourus en cas d'exposition au bruit.



PACEMAKERS ET PROTHÈSES AUDITIVES

Les champs magnétiques produits par les courants à haute tension peuvent affecter le fonctionnement des prothèses auditives et des pacemakers. Les personnes portant ce type d'appareil doivent consulter un médecin avant de s'approcher d'un lieu où s'effectue le coupage ou le gougeage plasma.

Pour réduire les risques associés aux champs magnétiques :

- Garder loin de soi et du même côté du corps le câble de retour et le faisceau de la torche.
- Faire passer le faisceau de la torche le plus près possible du câble de retour.
- Ne pas s'enrouler le faisceau de la torche ou le câble de retour autour du corps.
- Se tenir le plus loin possible de la source de courant.



UN ARC PLASMA PEUT ENDOMMAGER LES TUYAUX GELÉS

Les tuyaux gelés peuvent être endommagés ou éclater si l'on essaie de les dégeler avec une torche plasma.

Étiquette de sécurité

Cette étiquette est affichée sur la source de courant. Il est important que l'utilisateur et le technicien de maintenance comprennent la signification des symboles de sécurité. Les numéros de la liste correspondent aux numéros des images.



1. Les étincelles produites par le coupage peuvent provoquer une explosion ou un incendie.
 - 1.1 Pendant le coupage, éloigner toute matière inflammable.
 - 1.2 Conserver un extincteur à proximité et s'assurer qu'une personne soit prête à l'utiliser.
 - 1.3 Ne jamais couper de récipients fermés.
2. L'arc plasma peut provoquer des blessures et des brûlures.
 - 2.1 Couper l'alimentation avant de démonter la torche.
 - 2.2 Ne pas tenir la surface à couper près de la trajectoire de coupe.
 - 2.3 Porter des vêtements de protection couvrant tout le corps.
3. Un choc électrique causé par la torche ou les câbles peut être fatal. Se protéger contre les risques de chocs électriques.
 - 3.1 Porter des gants isolants. Ne pas porter de gants mouillés ou abîmés.
 - 3.2 S'isoler de la surface de travail et du sol.
 - 3.3 Débrancher la prise ou la source de courant avant de manipuler l'équipement.
4. L'inhalation des vapeurs produites par le coupage peut être dangereuse pour la santé.
 - 4.1 Garder le visage à l'écart des vapeurs.
 - 4.2 Utiliser un système de ventilation par aspiration ou d'échappement localisé pour dissiper les vapeurs.
 - 4.3 Utiliser un ventilateur pour dissiper les vapeurs.
5. Les rayons de l'arc peuvent brûler les yeux et provoquer des lésions de la peau.
 - 5.1 Porter un casque et des lunettes de sécurité. Se protéger les oreilles et porter une chemise dont le col peut être déboutonné. Porter un casque de soudure dont la protection filtrante est suffisante. Porter des vêtements protecteurs couvrant la totalité du corps.
6. Se former à la technique du coupage et lire les instructions avant de manipuler l'équipement ou de procéder au coupage.
7. Ne pas retirer ou peindre (recouvrir) les étiquettes de sécurité.

Section 2

SPECIFICATIONS

In this section:

Specifications, Power Supply	2-2
Specifications, PAC123 Torches	2-3
Symbols and Markings	2-4

Specifications, Power Supply

Rated Open Circuit Voltage (U_0)	300 VDC	
Rated Output Current (I_2)	20 A – 40 A	
Rated Output Voltage (U_2)	140 VDC	
Duty Cycle at 40°C (See data tag on power supply for more information on duty cycle.)	50 % ($I_2=40$ A, $U_2=140$ V) 100 % ($I_2=28$ A, $U_2=140$ V)	
Operating temperature	-10° to +40°C (+14° to 104° F)	
Apparent Input Power (S_1)	230/400 V = 6.7 kVA 208-240/480 V = 9.5 kVA	
Input Voltage (U_1)/ Input Current (I_1) at 5.6 kW Output	230 V/17 A – 3-phase, 50/60 Hz CE 400 V/9,7 A – 3-phase, 50/60 Hz CE 208-240 V/40-46 A – 1-phase, 50/60 Hz CSA/NRTL 480 V/12 A – 3-phase, 50/60 Hz CSA/NRTL	
Gas Type	Air	Nitrogen
Gas Quality	Clean, dry, oil-free	99.995 % pure
Gas Inlet Pressure and Flow	See Section 3, Setup	

Powermax600 Power Supply Dimensions and Weight

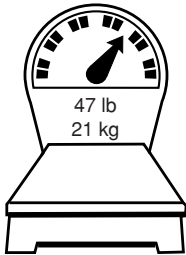

Weight with hand torch and 15 ft / 4.5 m lead.

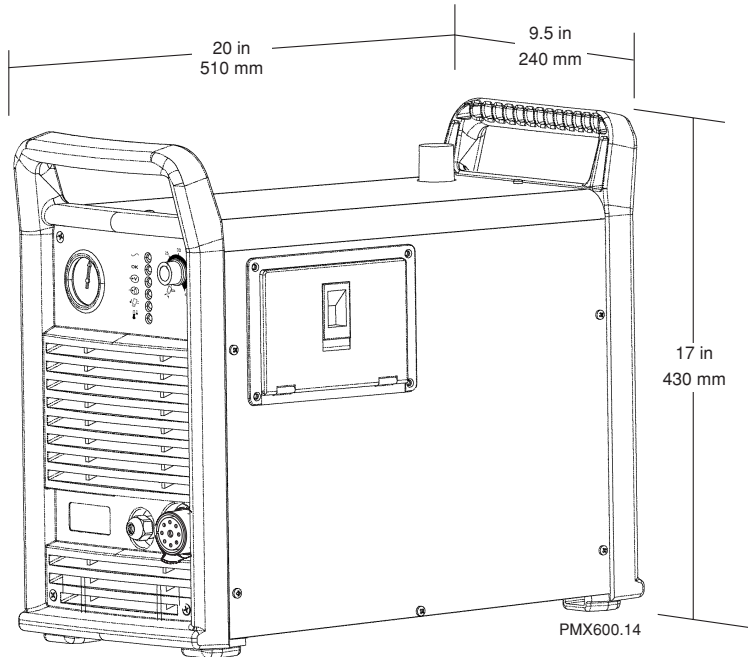

Specifications PAC123 Torches

Maximum Cutting Capacity	
40A PAC123T	5/8 inch / 16 mm @ 50 % duty cycle
40A PAC123M	1/4 inch / 6 mm @ 50 % duty cycle
28A PAC123M	1/8 inch / 3 mm @ 100 % duty cycle
Gouging Capability (metal removal rate)	
5.6 pounds / 2.5 kg / hour	
Weight	
PAC123T	3.5 pounds / 1.6 kg with 15 ft / 4.5 m lead
	4.5 pounds / 2 kg with 25 ft / 7.5 m lead
	7 pounds / 3.2 kg with 50 ft / 15 m lead
PAC123M	6 pounds / 2.7 kg with 15 ft / 4.5 m lead
	7 pounds / 3.2 kg with 25 ft / 7.5 m lead
	9.5 pounds / 4.3 kg with 50 ft / 15 m lead

PAC123T Hand Torch Dimensions

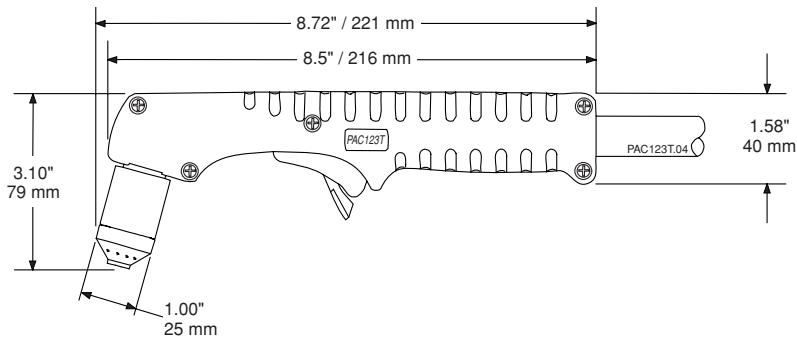

PAC123M Machine Torch Dimensions

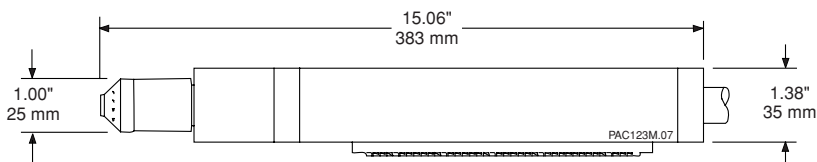











Symbols and Markings

S MARK (230/400 Volt only)

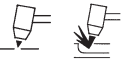
The **S** mark indicates that the power supply and torch are suitable for use in environments with increased hazard of electrical shock. The hand torches must have shielded consumable parts to maintain **S** mark compliance.

IEC Symbols Used

The following symbols may appear on the power supply data plate, control labels and switches.

	Direct Current (DC)		An inverter-based power source
	Alternating current (AC)		Plasma torch in the TEST position (cooling and cutting gas exiting nozzle)
	Plasma torch cutting and gouging		Power is on
	AC input power connection		Power is off
	The terminal for the external protective (earth) conductor		Volt/amp curve, "drooping" characteristic



Section 3

SETUP

In this section:

Lifting Power Supply	3-2
Power Hookup	3-2
Torch Hookup (Quick Disconnect Only)	3-5
Gas Hookup	3-5
PAC123M Machine Torch Setup	3-7

Lifting Power Supply

		WARNING
<p>The power supply weighs up to 54 lb / 25 kg. Do not lift the power supply by ONE handle. The handle can break, resulting in injury and damage to the power supply.</p>		

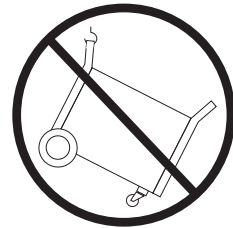
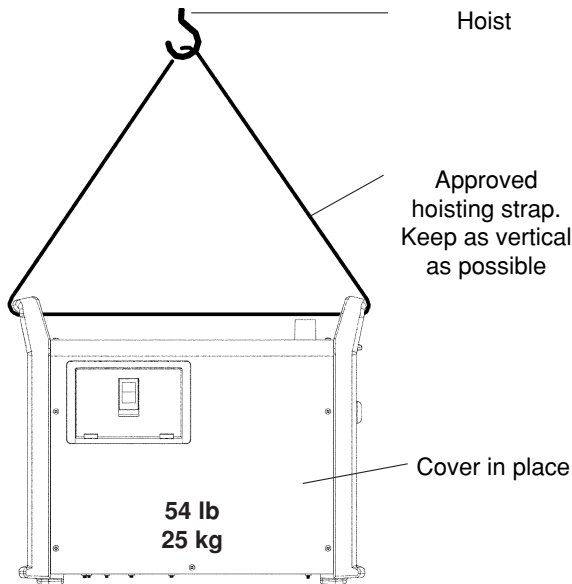





Power Hookup

Check Required Input Voltage

Look at U1 on the data plate to check input voltage requirements. The data plate is on the back of the power supply.



Hypertherm		CE
powermax600		
Plasma Cutting System		
HANOVER, NH 03755 MADE IN U.S.A.		
No. 086000 S/N		
3~		EN50199 EN50192
20A/88V-40A/96V		
	X@40°C HYP I ₂ 40A HYP U ₂ 140V IEC I ₂ 40A IEC U ₂ -	50% 60% 100% 36A 28A 140V 140V 34A 34A 96V 94V
20A/108V-40A/116V		
	X@40°C HYP I ₂ 40A HYP U ₂ 140V IEC I ₂ 40A IEC U ₂ 118V	50% 60% 100% 36A 28A 140V 140V 29A 29A 114V 111V
cos φ = .95		
U ₁	HYP I ₁ I _{EC} I _{max} I _{EC} I _{max} I _{EC} I _{eff}	I _{cutback} I _{searating}
HYP S ₁ 6.7KVA	(000V, 3ph) 9.7A	6.5A 8.0A 5.5A
IP23CS COOLING 		INSULATION 
110241 REV.A		

Power Hookup (Continued)

Install Power Cord Plug

Use a power cord plug that is certified by national or local electrical codes. The plug should be connected to the power cord by a licensed electrician.

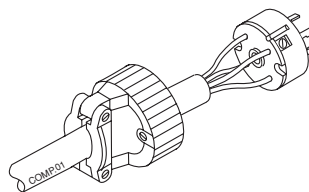

Extension Cord

Use a cord that is certified by national or local codes. The cord should be installed by a licensed electrician. Refer to the length requirements listed below.

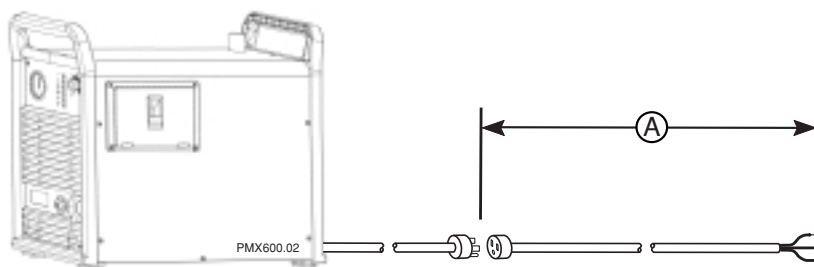

		Ⓐ				
		< 10 ft < 3 m	10-25 ft 3 – 7.5 m	25-50 ft 7.5 – 15 m	50-100 ft 15 – 30 m	100-150 ft 30 – 45 m
Input-Voltage	Phase	Recommended Cord Gauge Size (mm²)				
208-240 VAC	1	10	10	10	16	16
230 VAC	3	4	6	6	10	10
400 VAC	3	2.5	2.5	4	6	6
480 VAC	3	4	4	4	4	6
		Recommended Cord Gauge Size (AWG)				
208-240 VAC	1	8	8	8	6	6
230 VAC	3	12	10	10	8	8
400 VAC	3	14	14	12	10	10
480 VAC	3	12	12	12	12	10

Line Voltage Disconnect Box

Use a line disconnect box for each power supply so that the operator can turn the power supply off quickly in an emergency situation. Locate the switch near the power supply so that it is easily accessible to the operator. The interrupt level of the switch must be equal to or exceed the continuous rating of the fuses. Use slow-blow fuses as listed below.

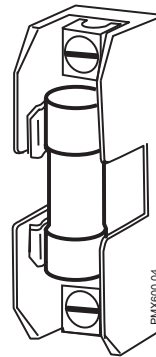
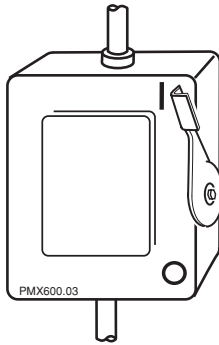

Input Voltage	Phase	Input Current @ 5.6 kw Output	Recommended Slow-Blow Fuse Size
208-240 VAC	1	46-40 A	100 A
230 VAC	3	17 A	40 A
400 VAC	3	9.7 A	25 A
480 VAC	3	12 A	25 A

Grounding Requirements

To ensure personal safety, proper operation and to reduce electromagnetic interference (EMI), the Powermax600 must be properly grounded:

- The power supply chassis is electrically conductive and can present a shock hazard if it is not properly grounded through the line voltage disconnect box.
- The power supply must be properly grounded through the power cord according to national or local electrical codes.
- Three-phase service must use a 4-wire cord that includes a protective earth ground.
- Also see *Grounding Safety*, in Section 1 of this manual.

Generator Power

When using a generator to power the Powermax600:

- Use a generator with a minimum auxiliary output of 8 kVA.
- The generator must be dedicated to powering the plasma cutting system.
- Generator Operation:
 1. Set the generator output to AC.
 2. Plug the Powermax600 power cord into the auxiliary power outlet.
 3. Set the generator to the appropriate output range. If the Powermax600 circuit breaker will not stay on, reduce the generator output.
- Use unshielded consumables if you experience difficulty with thicker material cutting (non-CE systems only).

Torch Hookup (For models with quick disconnect)

Install torch lead to power supply.

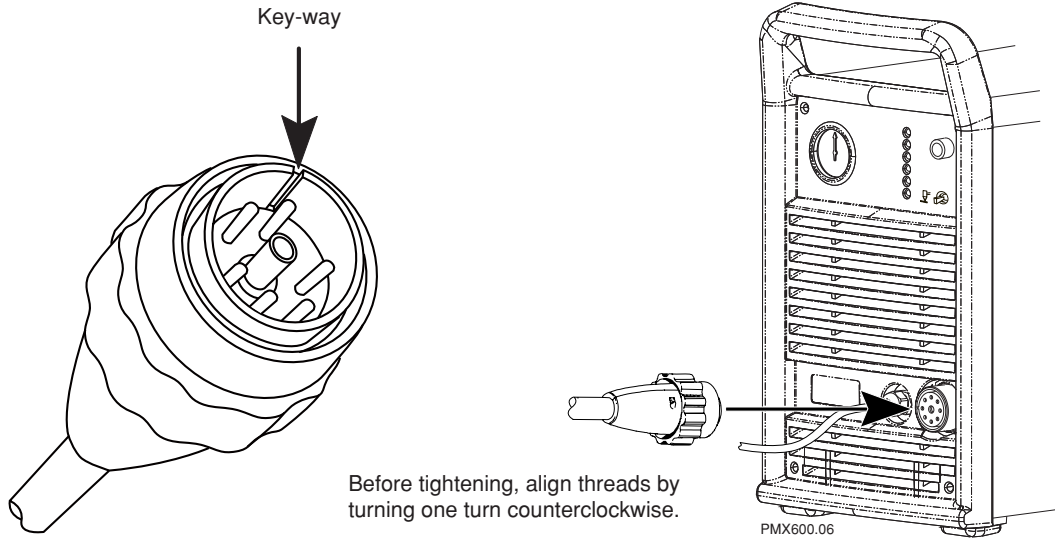

Gas Hookup

Gas Requirements

Air must be filtered to remove all dirt, water and oil. Contaminants can damage the power supply, torch and consumables.

The power supply will not power-up if the gas inlet pressure is below minimum.

CAUTION: Do not exceed 120 psi / 8.3 bar pressure at the power supply gas inlet. Damage to system may result from higher pressures.

Minimum Gas Inlet Pressure	90 psi / 6.2 bar
Gas Flow	6 scfm @ 90 psi / 170 l/min @ 6.2 bar

Gas Supply Connection

- Use an inert gas hose to connect the gas supply (air or nitrogen) to the power supply gas inlet.
- Apply liquid pipe sealant to the threads to ensure a leak-free installation.

CAUTION: Do not use Teflon tape on pipe threads. Pieces of tape can enter the air line and damage the system.

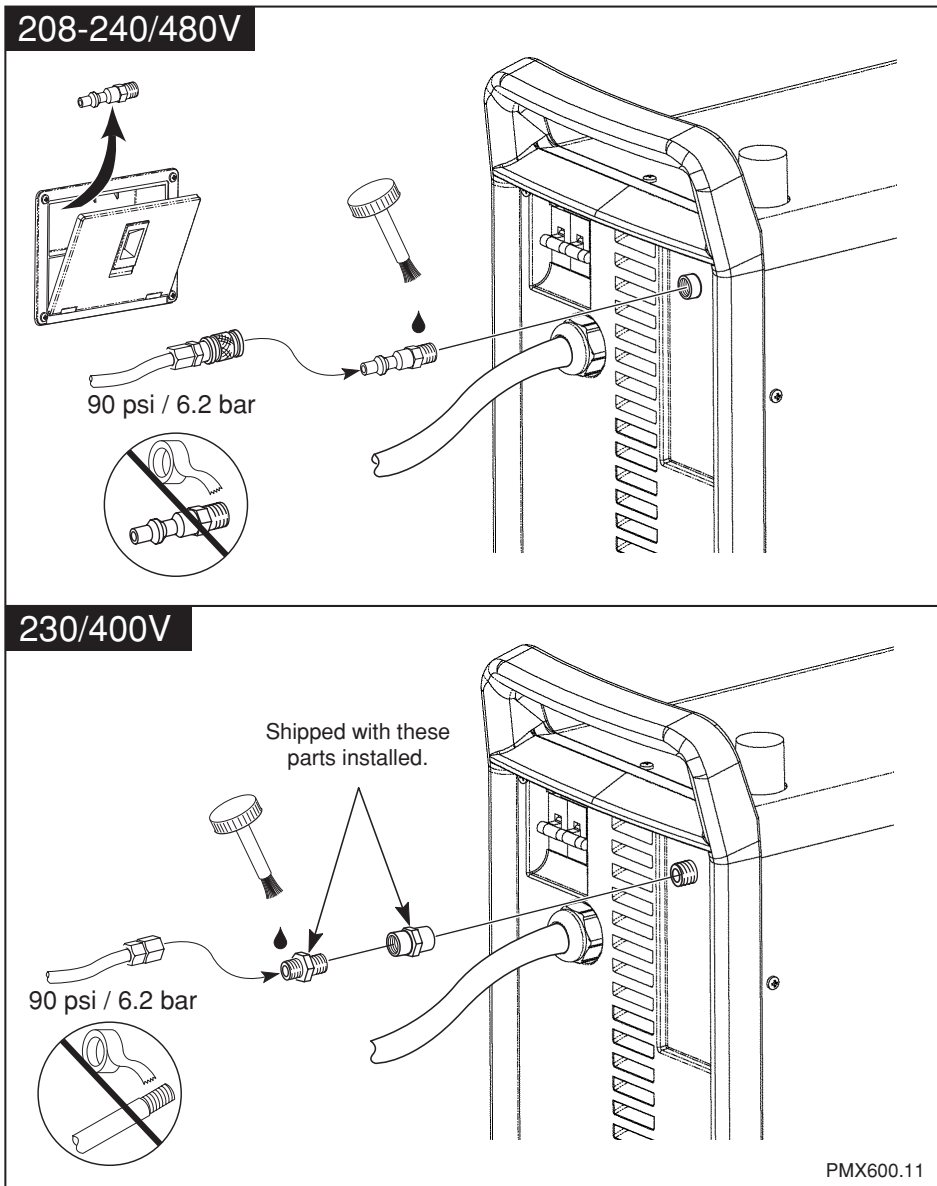

PMX600.11

PAC123M Machine Torch Setup

PAC123M ON/OFF Pendant Connection

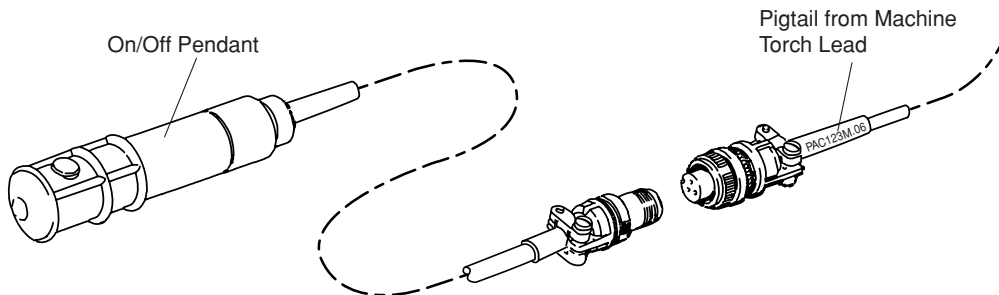

Socket A	White Wire
Socket B	Not Used
Socket C	Black Wire

PAC123M Torch Alignment

Mount the machine torch perpendicular to the workpiece in order to get a vertical cut. Use a square to align the torch at 0° and 90°.

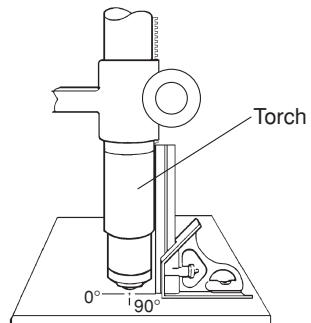

Section 4

OPERATION

In this section:

Controls and Indicators	4-2
Confirm Torch Consumables.....	4-3
installing Torch Consumables	4-4
Pilot Arc Control Switch (208-240/480 Volt Only).....	4-5
Turn On Power.....	4-5
Check Indicator Lights	4-5
Adjust Gas Pressure and Current Setting.....	4-6
Hand Torch Operation.....	4-7
Machine Torch Operation.....	4-12
Cut Chart	4-12

Controls and Indicators

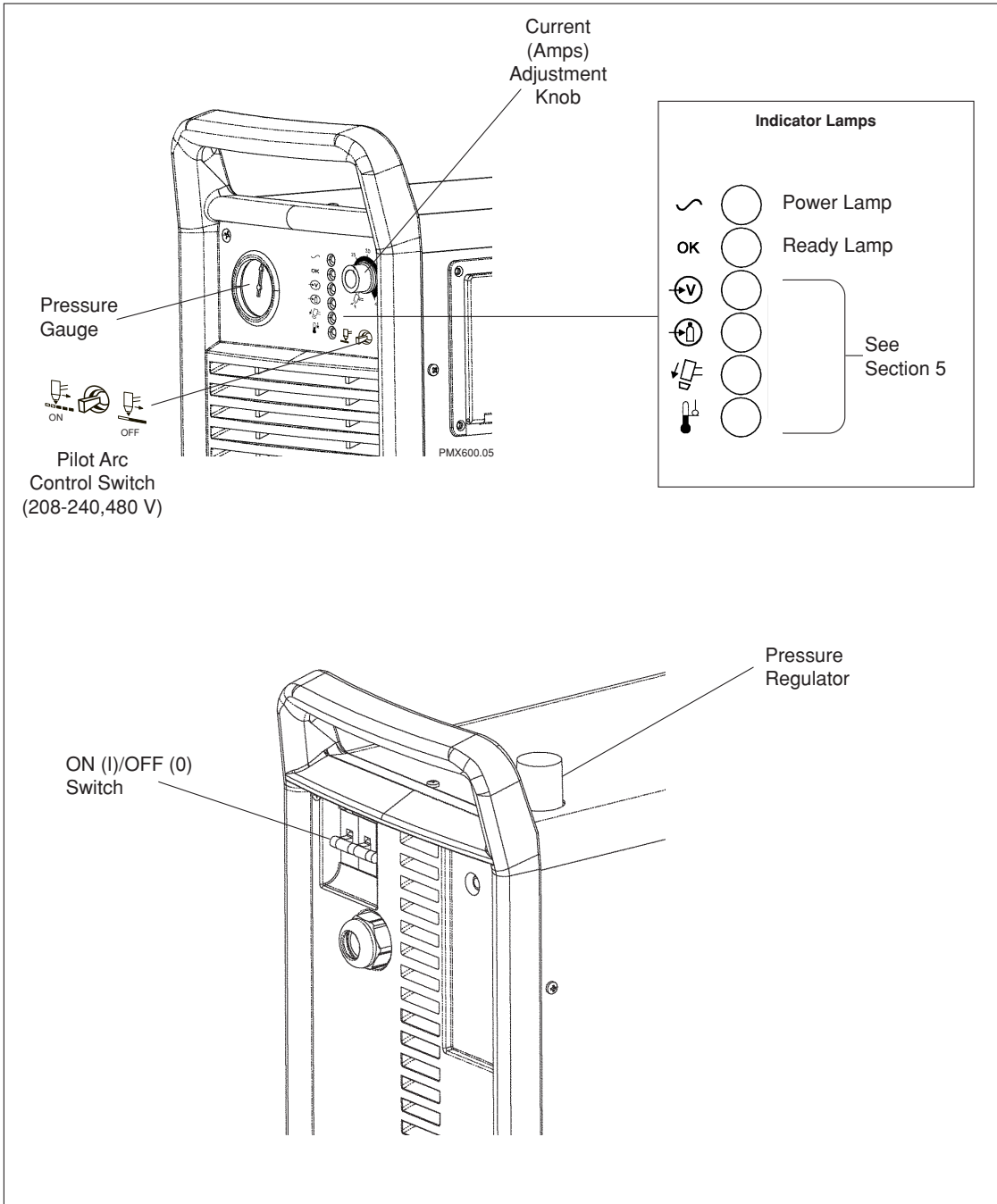

Confirm Torch Consumables

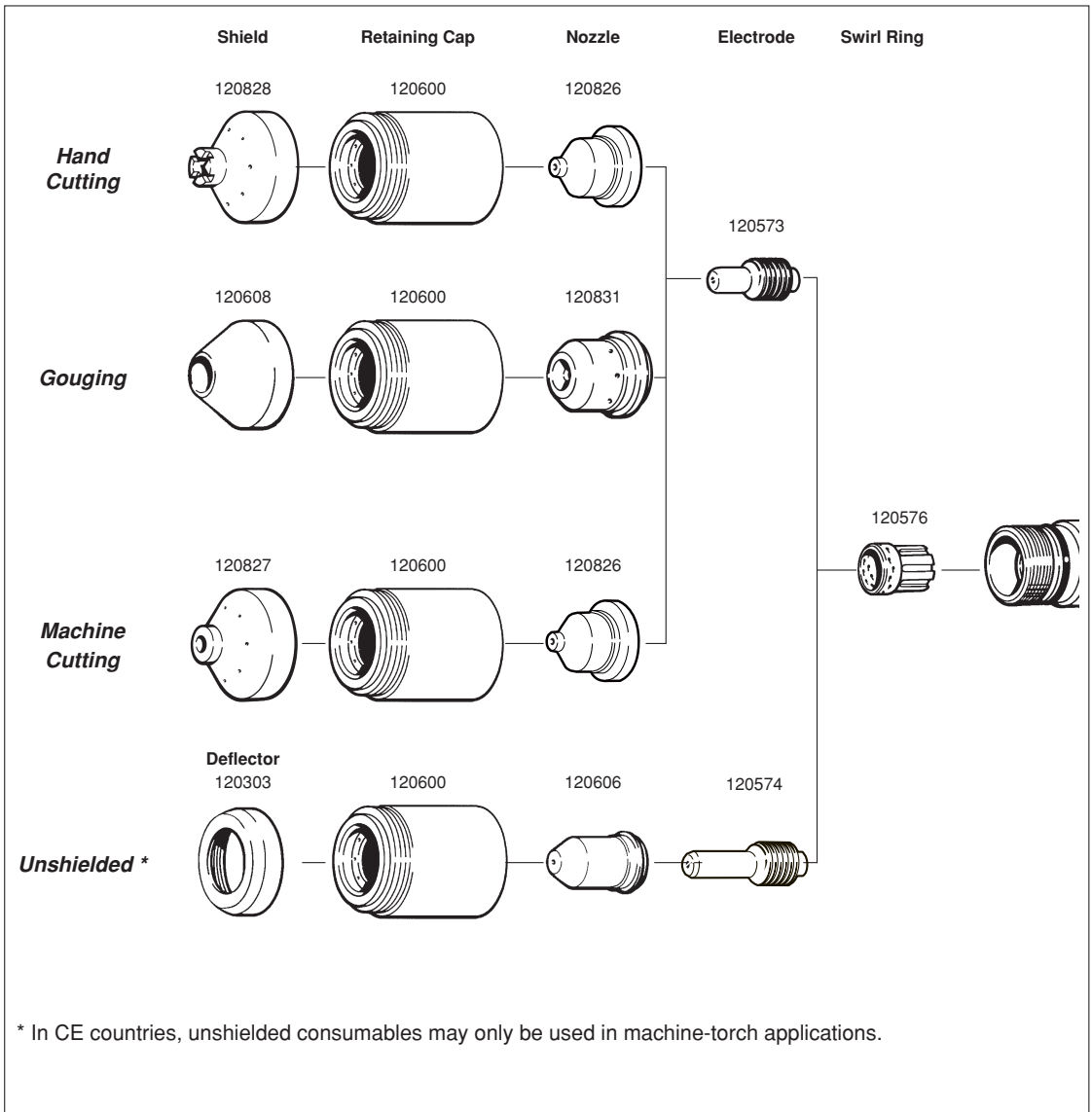



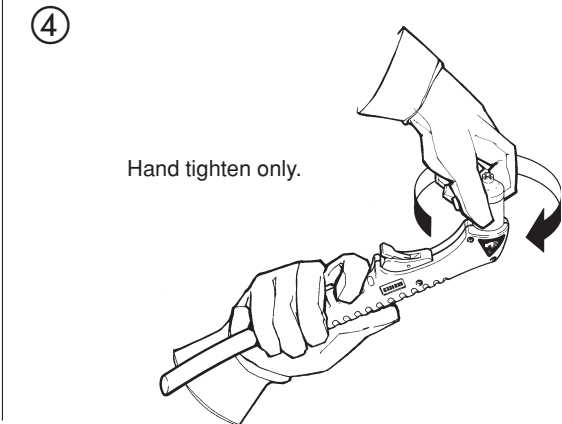
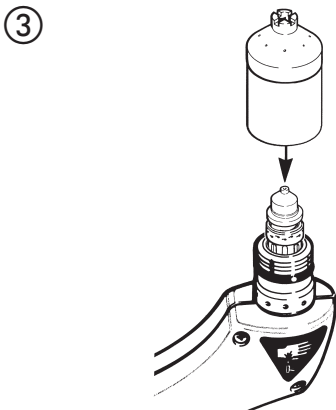
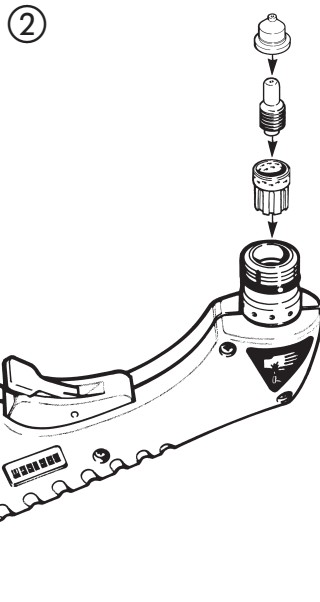
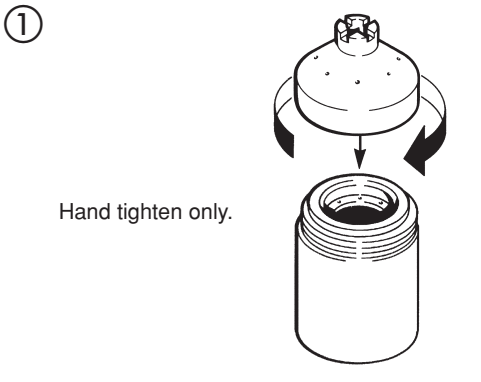

Installing Torch Consumables

		<p>WARNING INSTANT-ON TORCHES PLASMA ARC CAN CAUSE INJURY AND BURNS</p>
	<p>Plasma arc comes on immediately when the torch switch is activated. The plasma arc will quickly cut through gloves and skin. Make sure power is off before changing consumables.</p>	



Pilot Arc Control Switch (208-240/480 Volt Only)

<p>①</p> 	
<p>Use to cut expanded metal. Automatically reinitiates pilot.</p> 	<p>Use to cut plate/sheet metal. Optimum consumable life.</p>  <p style="text-align: right; font-size: small;">PMX600.07A</p>





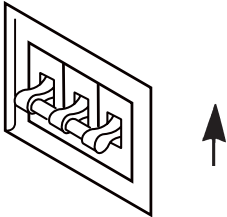

Turn On Power

①

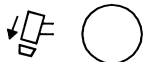

Position the power switch to ON.

Check Indicator Lights

<p>①</p> 	<p>Check that the POWER ON lamp is illuminated.</p>
<p>OK</p> 	<p>Check that the OK lamp is illuminated.</p>
<p>②</p> 	<p>Check that the remaining indicator lamps are NOT illuminated. See Section 5 for details.</p>
	
	
	

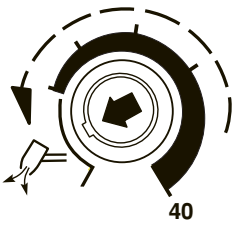

Adjust Gas Pressure and Current Setting

①

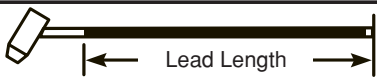
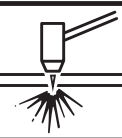

Turn the current adjustment knob to the gas test setting.

②

			
	15 ft 4.5 m	25 ft 7.5 m	50 ft 15 m
	72 psi 5.0 BAR	72 psi 5.0 BAR	78 psi 5.4 BAR
	50 psi 3.4 BAR	55 psi 3.8 BAR	60 psi 4.2 BAR

PMX600.18

- Look at the pressure gauge and check that the correct gas pressure is set.
- If the correct gas pressure is set, proceed to ⑤.
- If the gas pressure requires adjustment, proceed to ③.

③

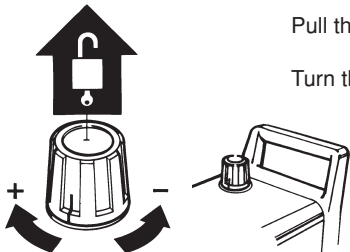

Pull the regulator knob up to unlock.

Turn the regulator knob to obtain the correct pressure.

④



Push the knob down to lock the regulator.

⑤

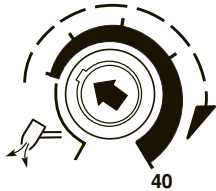

Turn the current adjustment knob to the desired amps setting.

Hand Torch Operation



WARNING
INSTANT-ON TORCHES
PLASMA ARC CAN CAUSE INJURY AND BURNS

Plasma arc comes on immediately when the torch switch is activated.
 The plasma arc will quickly cut through gloves and skin.

- Keep away from the torch tip.
- Do not hold the workpiece, and keep your hands clear of the cutting path.
- Never point the torch toward yourself or others.

Safety Trigger Operation

①

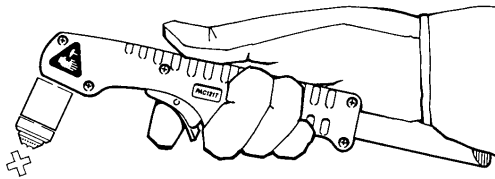

②

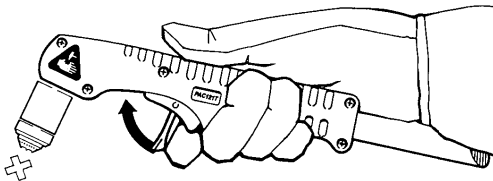

③

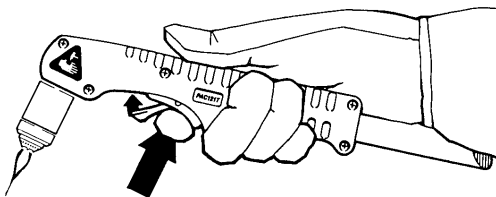

Avoid firing the torch when it is not in contact with the workpiece.

Hand Torch Cutting Technique

Firing the torch unnecessarily reduces nozzle and electrode life.



When cutting, make sure that sparks are exiting from the bottom of the workpiece.

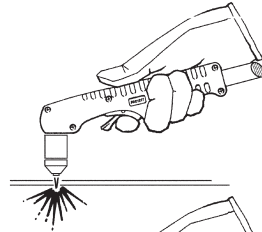

If sparks are spraying up from the workpiece, you are moving the torch too fast, or without sufficient power.

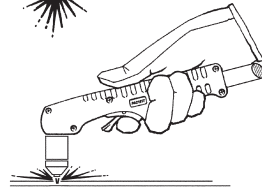

Hold the torch nozzle at a vertical position and watch the arc as it cuts along the line.

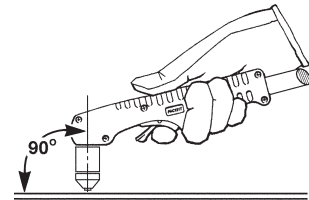

Unshielded Consumables. Maintain an approximate 1/16 inch / 1.5 mm torch-to-work distance.

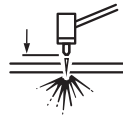

Shielded Consumables. Do not push down on the torch when cutting. Lightly drag the torch across the workpiece to maintain a steady cut.

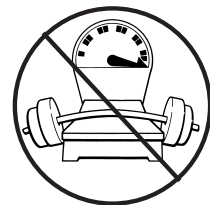

- Pulling the torch through the cut is easier than pushing it.
- To cut thin material, reduce the amps until you get the best quality cut.
- For straight-line cuts, use a straight edge as a guide. To cut circles, use a template or a radius cutter attachment.

Attach the Work Clamp

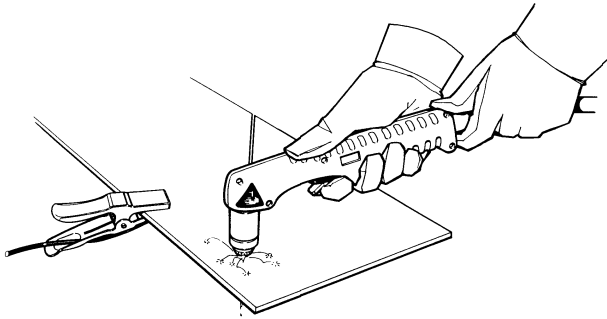

Attach the work clamp securely to the workpiece. Remove rust, paint or other coatings to ensure good electrical contact.

Attach the work clamp as close as possible to the area being cut, to reduce exposure to electromagnetic fields (EMF).

Do not attach it to the portion that will fall away.

Starting a Cut from the Edge of the Workpiece

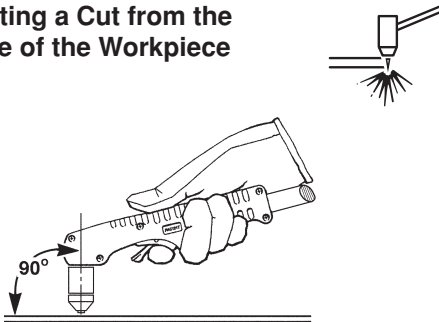

Hold the torch nozzle vertical at the edge of the workpiece.

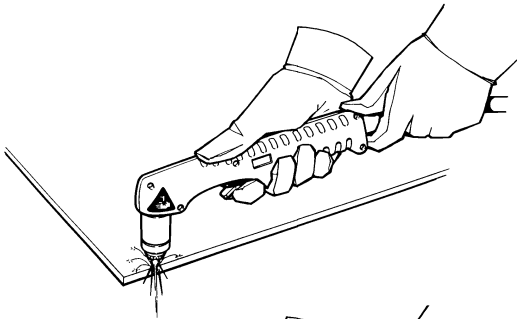

Start cutting from the edge of the workpiece.

Pause at the edge until the arc has completely cut through the workpiece.

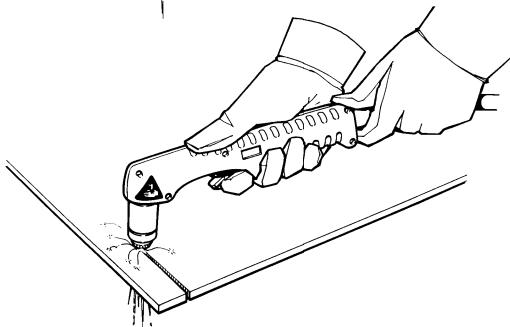

Then, proceed with the cut.

Piercing

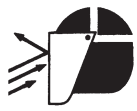
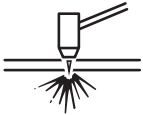

WARNING
SPARKS AND HOT METAL CAN INJURE
EYES AND BURN SKIN

When firing the torch at an angle, sparks and hot metal will spray out from the nozzle. Point the torch away from yourself and others.

Hold the torch so that the nozzle is within 1/16 inch / 1.5 mm from the workpiece before firing the torch.

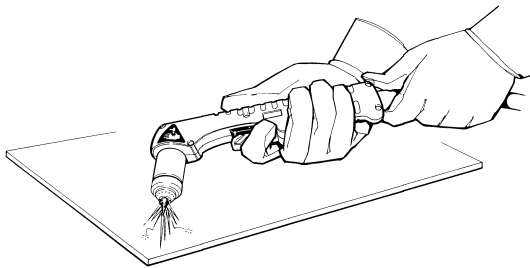

Fire the torch at an angle to the workpiece, then slowly rotate it to an upright position.

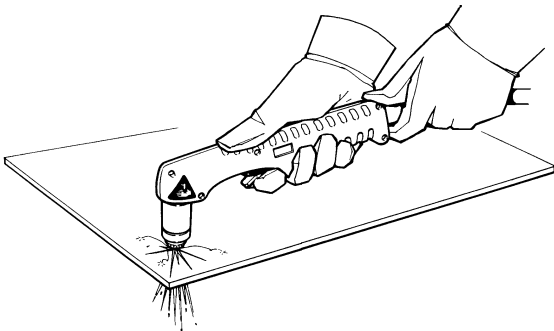

When sparks are exiting from the bottom of the workpiece, the arc has pierced through the material.

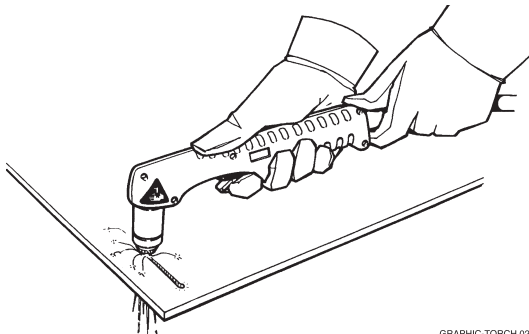

When the pierce is complete, proceed with the cut.

GRAPHIC-TORCH.02

Gouging

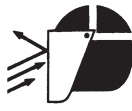

WARNING
SPARKS AND HOT METAL CAN INJURE
EYES AND BURN SKIN

When firing the torch at an angle, sparks and hot metal will spray out from the nozzle. Point the torch away from yourself and others.

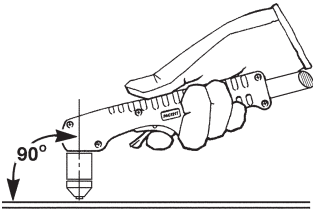

Hold the torch perpendicular to the workpiece.

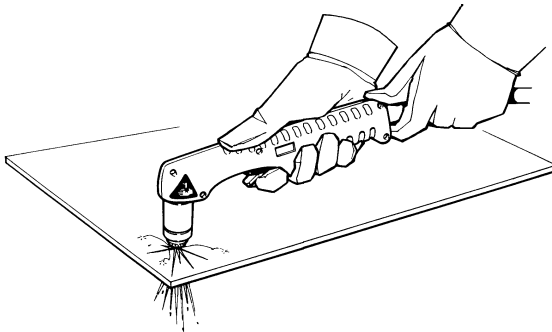

Pull the trigger to transfer the arc.

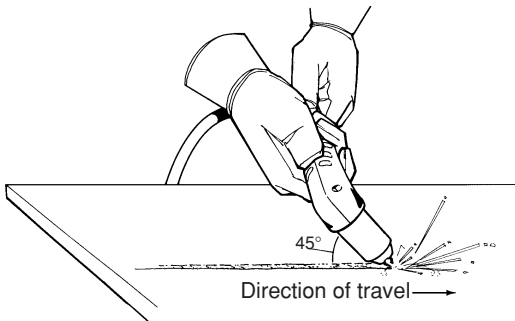







Rotate the torch to 45° from the workpiece.

Feed into the gouge.

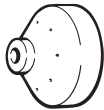
Machine Torch Operation

Cut Chart - 40 Amp Standard Consumables

- The following recommended settings are for mechanized cutting.
- Torch-to-work distance for the following cut chart is 1/16 inch / 1.5 mm for all cuts.

Shield 120827		Retaining Cap 120600		Nozzle 120826		Electrode 120573		Swirl Ring 120576		PAC123 Torch	
											
Material Thickness		Material	Arc Current (A)	Arc Voltage (VDC)	Recommended Travel Speed		Pierce Delay (Sec.)				
(ga. or in.)	(mm)				(ipm)	(mm/min.)					
26 ga.	0.5	Mild Steel	20	155	250	6850	0				
16 ga.	1.5	Mild Steel	20	155	385	1780	0				
16 ga.	1.5	Mild Steel	40	120	370	10150	0				
1/8"	3	Mild Steel	40	120	140	4950	0.5				
1/4"	6	Mild Steel	40	130	55	1680	1.0				
3/8"	10	Mild Steel	40	140	27	640	†				
1/2"	13	Mild Steel	40	140	19	460	†				
5/8"	16	Mild Steel	40	150	10	250	†				
0.020"	1	Aluminum	20	170	175	4150	0				
0.060"	1.5	Aluminum	20	170	125	3330	0				
16 ga.	1.5	Aluminum	40	130	420	10900	0				
1/8"	3	Aluminum	40	135	140	4450	0.5				
1/4"	6	Aluminum	40	140	53	1620	1.0				
3/8"	10	Aluminum	40	150	25	510	†				
1/2"	13	Aluminum	40	150	17	410	†				
5/8"	16	Aluminum	40	160	8	200	†				
26 ga.	0.5	Stainless Steel	20	160	235	5970	0				
16 ga.	1.5	Stainless Steel	20	160	50	1270	0				
16 ga.	1.5	Stainless Steel	40	130	400	10150	0				
1/8"	3	Stainless Steel	40	140	105	4060	0.5				
1/4"	6	Stainless Steel	40	140	44	1320	1.0				
3/8"	10	Stainless Steel	40	140	21	510	†				
1/2"	13	Stainless Steel	40	150	14	330	†				
5/8"	16	Stainless Steel	40	160	7	180	†				

† To cut material above 6 mm, start torch at edge of material.

MAINTENANCE AND PARTS







In this section:

Routine Maintenance	5-2
Inspect Consumables	5-3
Torch Lead Replacement	5-5
Work Cable Replacement	5-6
Power Cord Replacement	5-7
Air Filter Element Replacement	5-8
Basic Troubleshooting	5-10
Technical Questions	5-10
Parts	5-14
Torch Consumables	See Section 4
PAC123T Hand Torch Assembly (No Quick Disconnect)	5-14
PAC123T Hand Torch Assembly (With Quick Disconnect)	5-16
PAC123M Machine Torch Assembly (No Quick Disconnect)	5-18
PAC123M Machine Torch Assembly (With Quick Disconnect)	5-20
Power Supply - Filter Regulator	5-22
Power Supply - Work Cable	5-22
Powermax600 Labels	5-23
Powermax600 Field Upgrade Kits and Optional Parts	5-23

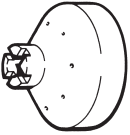
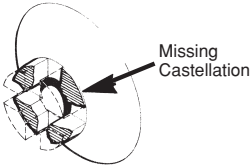
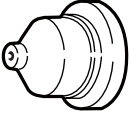

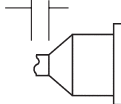
Routine Maintenance

		<p>WARNING ELECTRIC SHOCK CAN KILL</p>
		<p>Disconnect electrical power before performing any maintenance. All work requiring removal of the power supply cover must be performed by a qualified technician.</p>
<p>Each Use</p>	<p>Check gas pressure.</p>	<p>Check consumables for proper installation and wear.</p>
		<p>Check torch cap-on safety switch: listen for "click" when the retaining cap is loosened.</p>
<p>Each Week</p>		
<p>3 Months</p>	<p>Replace damaged labels.</p>	<p>Check trigger for damage. Check torch body for cracks and exposed conductors.</p>
<p>Replace damaged power cord or plug.</p>	<p>Replace damaged torch lead.</p>	<p>Check pressure hose and connections for leaks.</p>
<p>6 Months</p>	<p>Clean the inside of the power supply with air pressure or vacuum.</p>	

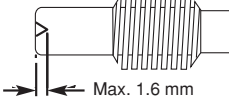

Inspect Consumables

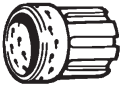
Part	Check For	Limit	Action
 <p>Shield</p> <p>External surfaces</p> <p>Edge gas holes</p> <p>Center hole</p>	<p>Wear of castellations</p> <p>Blocked holes</p> <p>Round</p> <p>Signs of arcing</p>	 <p>Castellations must not be worn off.</p> <p>None</p> <p>Hole must be round</p> <p>None</p>	<p>Replace</p> <p>Clear by pushing a pin through blocked hole from the inside</p> <p>Replace</p> <p>Replace</p>
 <p>Nozzle</p> <p>Nozzle tip</p> <p>Center hole</p>	<p>Even wear or erosion</p> <p>Side wear or erosion</p> <p>Round (View from inside)</p> 	<p>1/32 inch / 1 mm minimum remaining</p>  <p>None</p>  <p>Hole must be round</p> 	<p>Replace</p> <p>Replace</p> <p>Replace</p>
 <p>Electrode</p> <p>Center surface</p>	<p>Wear</p>	 <p>Pit not more than 1/16 inch / 1.6 mm deep</p>	<p>Replace</p>

Inspect Consumables (Continued)

<i>Part</i>	<i>Check For</i>	<i>Limit</i>	<i>Action</i>
 <p>Swirl Ring</p> <p>External surfaces</p> <p>Edge gas holes</p>	Damage or debris	Clean and no damage	Replace
	Blocked holes	None	Replace
 <p>Torch O-ring</p> <p>External surfaces</p>	Damage or wear	None	Replace
	Lubricated	Not dry	Apply a thin film of silicone lubricant.

Torch Lead Replacement (For Models Without Quick Disconnect)

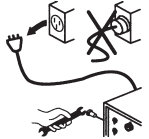
		<p>WARNING ELECTRIC SHOCK CAN KILL</p>
		<p>Disconnect electrical power before performing any maintenance. All work requiring removal of the power supply cover must be performed by a qualified technician.</p>

Disconnect electrical power and gas supply before removing the old torch lead.

Installation

CAUTION: Do not tighten the strain relief collar (4) onto the torch lead until the gas fitting (3) is tight, or the gas connection may leak.

1. Install the strain relief (1) and secure with nut (2).
2. Connect and tighten the gas fitting (3).
3. Tighten the strain relief collar (4) onto the lead.
4. Connect the electrical connections (5), (6) and (7).
Tighten the terminal block screws to 10 in-lb / 12 kg cm of torque.
5. Install the power supply cover.
6. Reconnect electrical power and gas supply.

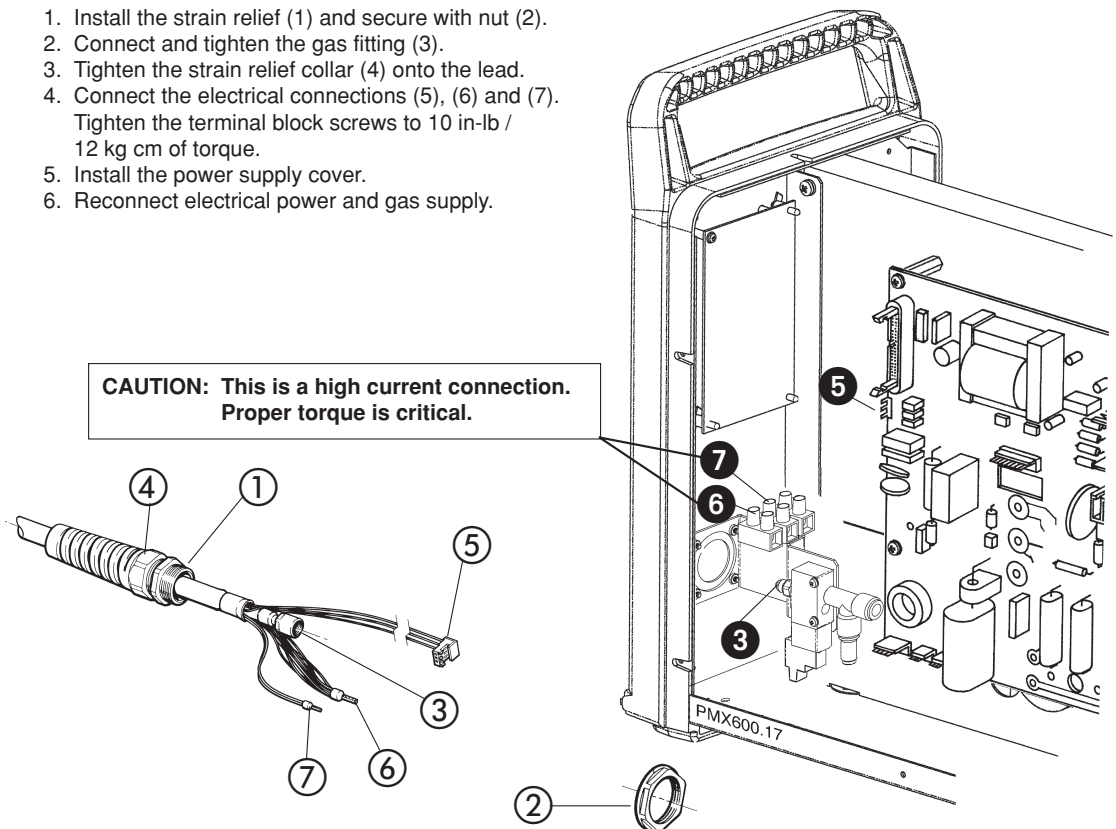

Work Cable Replacement

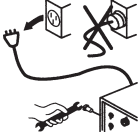
	<p>WARNING ELECTRIC SHOCK CAN KILL</p>
	<p>Disconnect electrical power before performing any maintenance. All work requiring removal of the power supply cover must be performed by a qualified technician.</p>

Disconnect electrical power and gas supply before removing the old work cable.

Installation

1. Install the strain relief (1) to the power supply and secure with nut (2).
2. Install the work cable (3) through the strain relief.
3. Tie a knot (4) in the end of the work cable.
4. Tighten the strain relief collar (5) onto the cable.
5. Connect the work cable to the terminal block (6).
Tighten the terminal block screw to 10 in-lb / 12 kg cm of torque.
6. Install the power supply cover. Reconnect electrical power and gas supply.

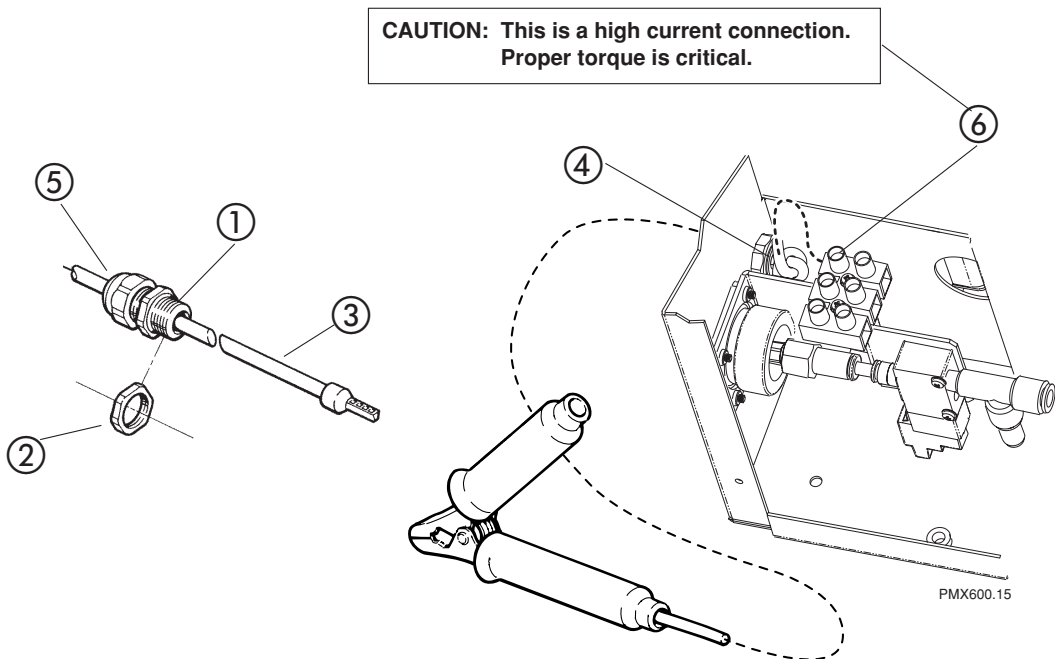

Power Cord Replacement

		WARNING ELECTRIC SHOCK CAN KILL
		Disconnect electrical power before performing any maintenance. All work requiring removal of the power supply cover must be performed by a qualified technician.

Disconnect electrical power and gas supply before removing the old power cord.

Installation

1. Insert the new power cord through the strain relief.
2. Pass all 4 wires through the toroid, as shown (230 and 400 volt only).
3. Install the power cord connections where shown.
4. Tighten the strain relief onto the power cord.
5. Install the power supply cover.
6. Reconnect electrical power and gas supply.

<p>230V and 400V</p>	<p>NOTE: Toroid must be installed for power supply to be in compliance with EMC standard EN50199.</p> <div style="display: flex; justify-content: space-around;"> <div data-bbox="638 980 893 1197"> <p>230V</p> <p>Pass all 4 wires through the toroid 2 times.</p> </div> <div data-bbox="900 980 1162 1197"> <p>400V</p> <p>Pass all 4 wires through the toroid 3 times.</p> </div> </div>
<p>208V - 240V</p>	<p>480V</p>

PMX600.12

Air Filter Element Replacement

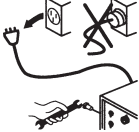
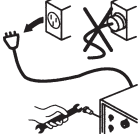
		<p>WARNING ELECTRIC SHOCK CAN KILL</p>
		<p>Disconnect electrical power before performing any maintenance. All work requiring removal of the power supply cover must be performed by a qualified technician.</p>

Removal

- Disconnect electrical power.
- Disconnect gas supply.
- Remove the power supply cover.

- ① Compress the hose fitting collar and pull the gas hose from the hose fitting.
- ② Pull the drain hose from the grommet in the floor of the power supply.

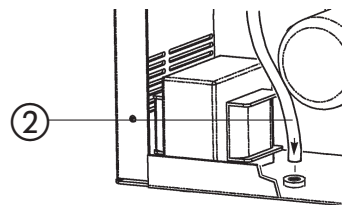
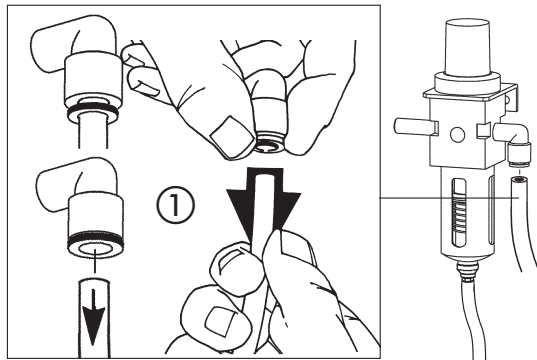

- ③ Unscrew the filter bowl. Do not discard the O-ring.
- ④ Remove the filter element from the filter housing.

NOTE: Do not allow the filter element to turn when loosening the screw.

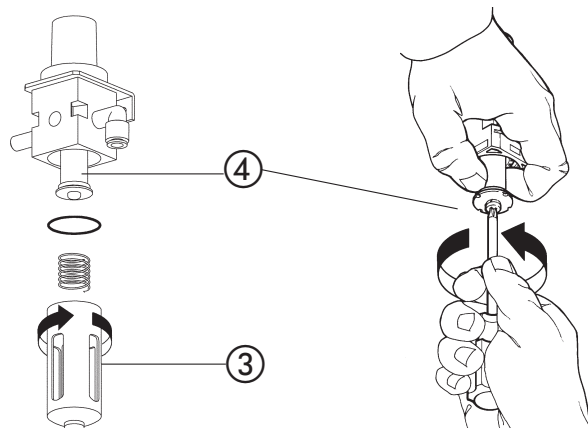

Air Filter Element Replacement (continued)

Installation

- ① Install the new filter element into the filter housing.
Secure with screw and retainer.

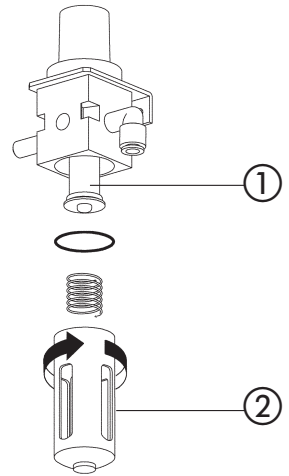

- ② Install the filter bowl and O-ring into the filter housing.

- ③ Push the pressure line fully into the hose fitting.

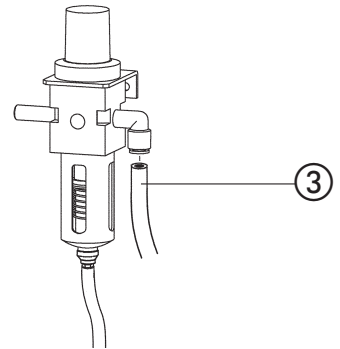

- ④ Install the drain hose into the grommet.

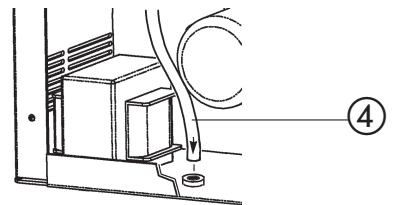

- Install the power supply cover.
- Reconnect electrical power and gas supply.

Basic Troubleshooting

Controls and Indicator Lamps

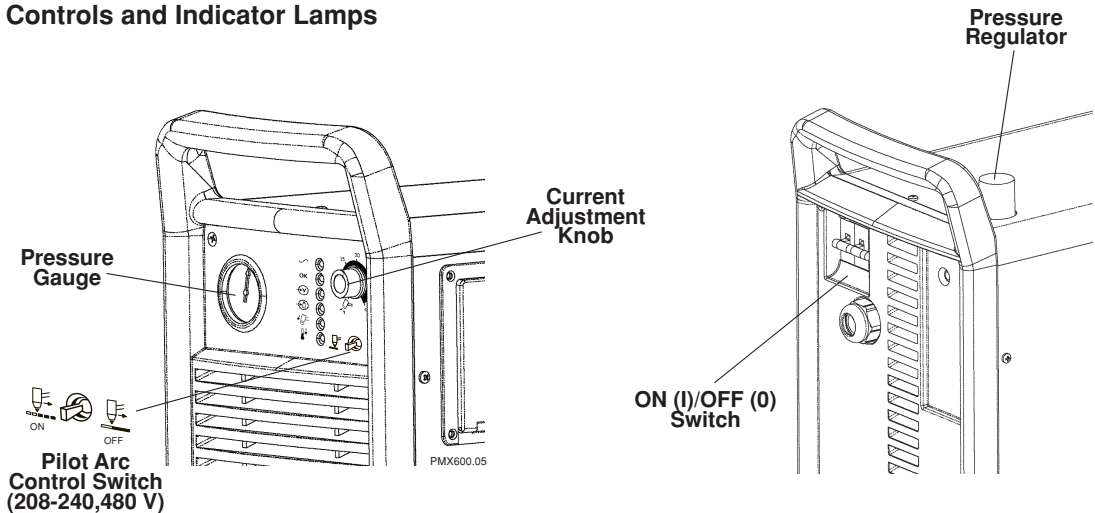

Green POWER IS ON

When illuminated, indicates that AC voltage is supplied to the power supply and that the ON/OFF switch is in the ON position.



Green SYSTEM READY

When illuminated, indicates that circuits are activated and that all fault conditions are clear (none of the yellow lamps are illuminated).



Yellow LOW LINE VOLTAGE

When illuminated, indicates that the AC line voltage is: 1) below operating limits, or 2) is missing 1 phase (230V and 400V systems only).



Yellow LOW GAS PRESSURE

When illuminated, indicates that the incoming gas pressure is below operating limits.

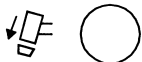

Yellow TORCH PARTS ARE LOOSE OR REMOVED

When illuminated, indicates that the torch consumables are loose or not installed.



Yellow HIGH TEMPERATURE

When illuminated, indicates that the power supply temperature has exceeded operating limits.

Problem

Cause / Solution

1. The ON/OFF power switch is set to I (ON), but the fan does not operate and the POWER ON lamp is not illuminated.



- 1.1 The power cord is not plugged into the power receptacle.**

Plug the power cord into the receptacle.

- 1.2 The disconnect power switch is not set to ON or there is no power available to the disconnect power switch box.**

Turn on the power at the main power panel or at the disconnect power switch box.

2. The POWER ON lamp is illuminated and the LOW GAS PRESSURE lamp is illuminated.



- 2.1 The gas supply is turned OFF or not connected to the power supply.**

Check that the gas is turned on and is connected to the power supply.

- 2.2 The incoming gas pressure is too low.**

Set incoming gas pressure to 90-120 psi / 6.2-8.3 bar. Check that there are no leaks in the gas supply line.

3. The POWER ON lamp is illuminated and the LOW LINE VOLTAGE lamp is illuminated.



- 3.1 Line voltage is too low or a phase is missing.**

The following table lists the operating range of the Powermax600 power supplies. Have an electrical technician check incoming power.

Note: To avoid performance deterioration, input voltage should be within 10% of the specified system line voltage.

208 Low Line Conditions: Symptoms include difficulty maintaining pilot arc or cutting thicker material. System performance can be improved by reducing output setting or by using non-shielded consumables.

	Lower Limit	System Line Voltage	Upper Limit
	180 VAC	208-240 VAC	276 VAC
	189 VAC	230 VAC	270 VAC
	328 VAC	400 VAC	470 VAC
	408 VAC	480 VAC	552 VAC

4. The power supply shuts off after you turn it on (208-240 or 230 volt unit only).

- 4.1 The line voltage is too high.**



See table above. Have an electrical technician check incoming power.

5. The POWER ON lamp is illuminated and the HIGH TEMPerature lamp is illuminated.



- 5.1 One of the internal thermostat switches has opened due to overheating.**

Leave the power supply on to allow the fan to cool the power supply.

Problem	Cause / Solution
<p>6. The POWER ON lamp is illuminated and the SYSTEM READY lamp is not illuminated.</p> <p>OK </p>	<p>6.1 The Start Lock-out is activated. If the power supply is turned on while the torch trigger is pressed, the system ready lamp will not illuminate and the torch will be disabled. To clear fault, release the torch trigger and turn off the power supply and then turn it on.</p> <p>6.2 Torch consumables are loose or removed from the torch. If the torch consumables become loose or are removed while the power supply is on, the system ready lamp will not illuminate and the torch will be disabled. To clear fault, turn off power supply and tighten or install torch consumables. See <i>Installing Torch Consumables</i>, Section 4.</p>
<p>7. The POWER ON lamp is illuminated and the TORCH PARTS LOOSE OR REMOVED lamp is illuminated.</p> <p> </p>	<p>7.1 Torch consumables are loose or removed from the torch. Turn off power supply and tighten or install torch consumables. See <i>Installing Torch Consumables</i>, Section 4.</p> <p>If the torch consumables become loose or were removed while the power supply is on, turn off the power supply, correct the problem and then turn on the power supply to clear this fault.</p>
<p>8. The arc does not transfer to the workpiece.</p>	<p>8.1 The work clamp is not connected to the workpiece, or the work clamp is broken. Connect or repair the work clamp.</p> <p>8.2 The work clamp is not making good metal-to-metal contact. Clean the area where the clamp contacts the workpiece.</p> <p>8.3 The torch is too far away from the workpiece. Move the torch head closer to the workpiece and start the torch again. See <i>Torch Operation</i>, Section 4.</p>

Problem	Cause / Solution
<p>9. The arc blows out, but re-ignites when the torch switch is depressed again.</p>	<p>9.1 <i>The consumable parts are worn or damaged.</i> Inspect and change the consumable parts, if necessary. See <i>Inspect Consumables</i>, in this section. See <i>Torch Operation</i>, Section 4.</p> <p>9.2 <i>The gas pressure is incorrect.</i> Adjust the operating gas pressure. See <i>Check and Adjust Gas Pressure</i>, Section 4. Check that the gas pressure to the power supply is not less than 90 psi / 6.2 bar at a flow of 6 scfm / 170 l/m.</p> <p>9.3 <i>The gas filter element inside the power supply is contaminated.</i> Replace element - See <i>Air Filter Element Replacement</i>, in this section.</p>
<p>10. The arc sputters and hisses.</p>	<p>10.1 <i>The gas filter element inside the power supply is contaminated.</i> Replace element - See <i>Air Filter Element Replacement</i>, in this section.</p> <p>10.2 <i>There is water in the air line.</i> Install or repair air filtration to power supply - See <i>Gas Requirements</i>, Section 3.</p>
<p>11. Cut quality is not good.</p>	<p>11.1 <i>Consumables are worn or the torch is being used incorrectly .</i> See <i>Inspect Consumables</i>, in this section. See <i>Hand Torch Operation</i>, Section 4.</p>

Technical Questions

If you are unable to fix the problem by following this basic troubleshooting guide or if you need further assistance:

1. Call your Hypertherm distributor or authorized Hypertherm repair facility.
2. Call nearest Hypertherm office listed in the front of this manual.
3. See the Powermax600 Service Manual for wiring diagrams, higher-level troubleshooting and more parts list information.

Parts

PAC123T Hand Torch Assembly (No Quick Disconnect)

Item	Part Number	Description	Quantity
	086001*	PAC123T Hand Torch Assembly with 15 ft / 4.5 m Lead (No Quick Disconnect)	
	086002*	PAC123T Hand Torch Assembly with 25 ft / 7.5 m Lead (No Quick Disconnect)	
	086003*	PAC123T Hand Torch Assembly with 50 ft / 15 m Lead (No Quick Disconnect)	
1	001288	Handle, 2 Sides	1
2	002244	Safety Trigger	1
3	128377	Replacement Start Switch (switch and wire splices)	1
4	027254	Trigger Spring	1
5	004764	Retaining Ring, Gutcha	1
6	075339	Screws, P/S, # 4 X 1/2, PH, RND, S/B	5
7	120570	Torch Main Body with Safety Switch	1
8	044016	O-Ring: BUNA 90 Duro .614X.070	1
9	129475	Replacement Torch Lead, 15 ft / 4.5 m	1
9	129476	Replacement Torch Lead, 25 ft / 7.5 m	1
9	129477	Replacement Torch Lead, 50 ft / 15 m	1
* Top assembly includes the following consumables (See page 4-3 for details of consumable parts):			
	120573	Electrode	1
	120576	Swirl Ring	1
	120600	Retaining Cap	1
	120826	Nozzle	1
	120828	Shield	1

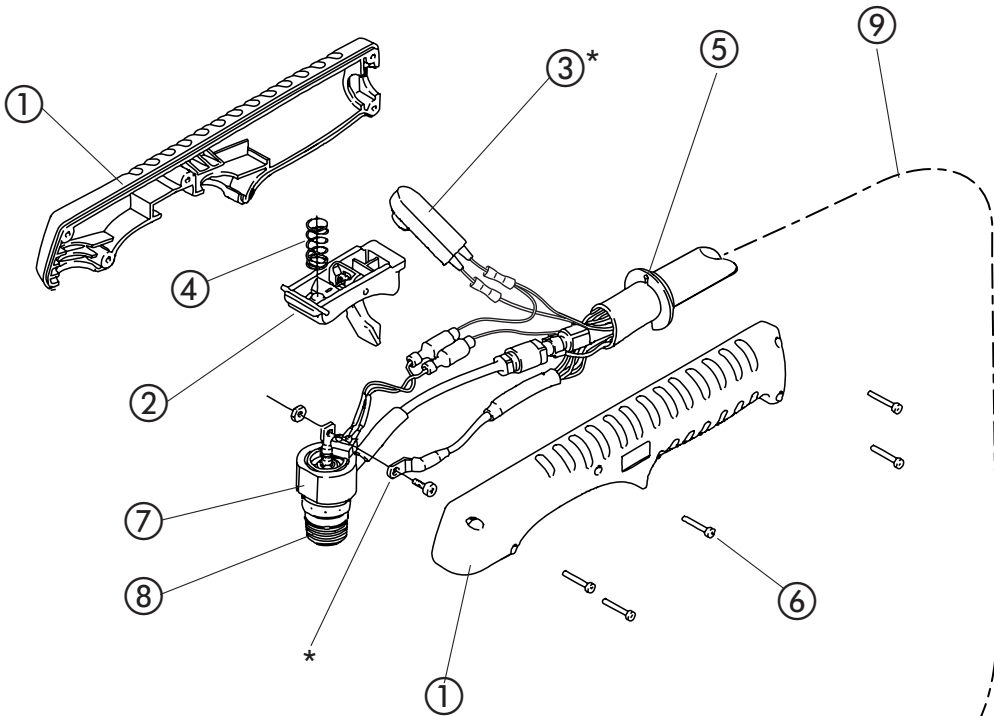

* Included with replacement assembly.

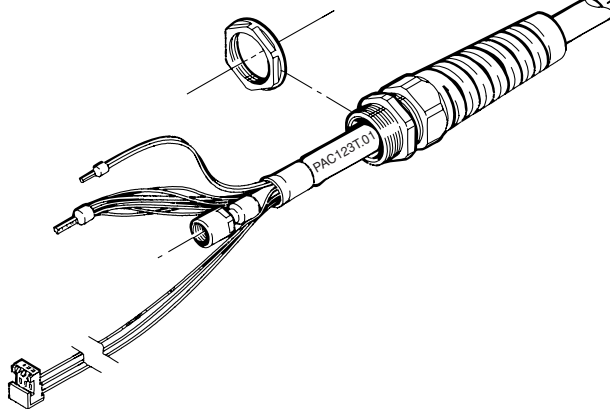

PAC123T Hand Torch and Lead Assembly - No Quick Disconnect

PAC123T Hand Torch Assembly (With Quick Disconnect)

Item	Part Number	Description	Quantity
	086023*	PAC123T Hand Torch Assembly with 15 ft / 4.5 m Lead and Quick Disconnect	
	086024*	PAC123T Hand Torch Assembly with 25 ft / 7.5 m Lead and Quick Disconnect	
	086025*	PAC123T Hand Torch Assembly with 50 ft / 15 m Lead and Quick Disconnect	
1	001288	Handle, 2 Sides	1
2	002244	Safety Trigger	1
3	128377	Replacement Start Switch (switch and wire splices)	1
4	027254	Trigger Spring	1
5	004764	Retaining Ring, Gutcha	1
6	075339	Screws, P/S, # 4 X 1/2, PH, RND, S/B	5
7	120570	Torch Main Body with Safety Switch	1
8	044016	O-Ring: BUNA 90 Duro .614X.070	1
9	129599	Replacement Torch Lead, 15 ft / 4.5 m	1
9	129600	Replacement Torch Lead, 25 ft / 7.5 m	1
9	129601	Replacement Torch Lead, 50 ft / 15 m	1

* Top assembly includes the following consumables (See page 4-3 for details of consumable parts):

	120573	Electrode	1
	120576	Swirl Ring	1
	120600	Retaining Cap	1
	120826	Nozzle	1
	120828	Shield	1

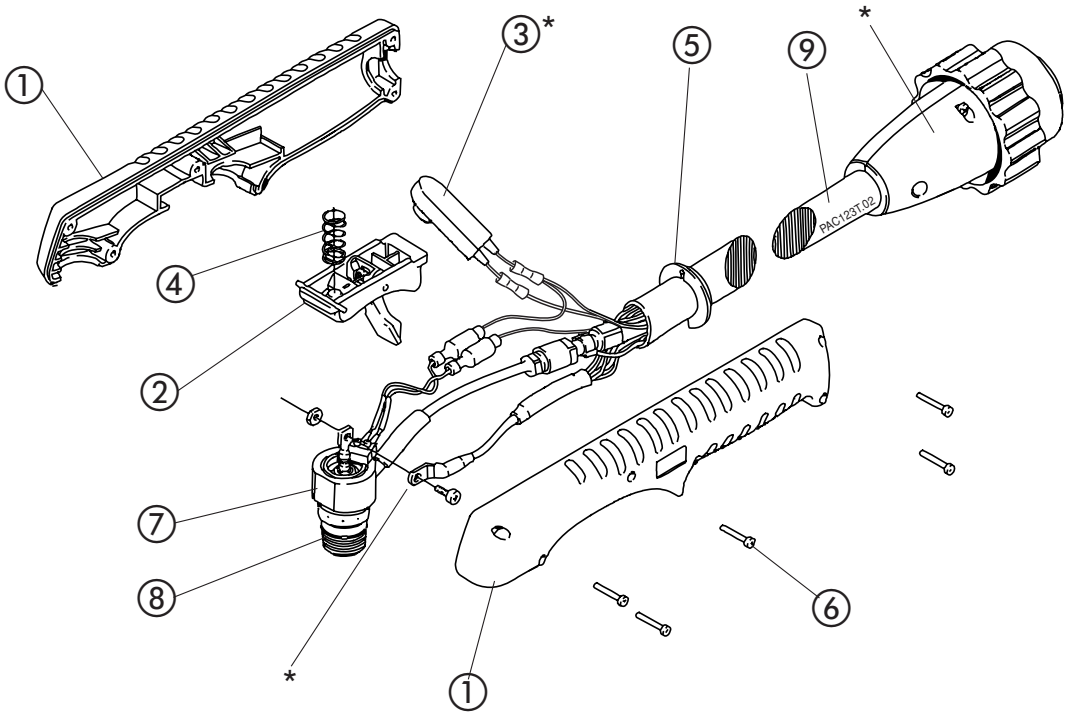

* Included with replacement lead assembly.

PAC123T Hand Torch and Lead Assembly - With Quick Disconnect

PAC123M Machine Torch Assembly (No Quick Disconnect)

Item	Part Number	Description	Quantity
	086004*	PAC123M Machine Torch Assembly with 15 ft / 4.5 m Lead (No Quick Disconnect)	
	086005*	PAC123M Machine Torch Assembly with 25 ft / 7.5 m Lead (No Quick Disconnect)	
	086006*	PAC123M Machine Torch Assembly with 50 ft / 15 m Lead (No Quick Disconnect)	
1	120613	Sleeve, Machine Torch	1
2	020620	Sleeve, Torch Position	1
3	128374	Replacement Torch Lead, 15 ft / 4.5 m	1
3	128375	Replacement Torch Lead, 25 ft / 7.5 m	1
3	128376	Replacement Torch Lead, 50 ft / 15 m	1
4	027599	Snap Ring	1
5	120583	Torch Main Body with Safety Switch	1
6	044016	O-Ring: BUNA 90 Duro 0.614 X 0.070 inch	1
* Top assembly includes the following consumables (See page 4-3 for details of consumable parts):			
	120573	Electrode	1
	120576	Swirl Ring	1
	120600	Retaining Cap	1
	120826	Nozzle	1
	120827	Shield	1

* Included with replacement lead assembly.

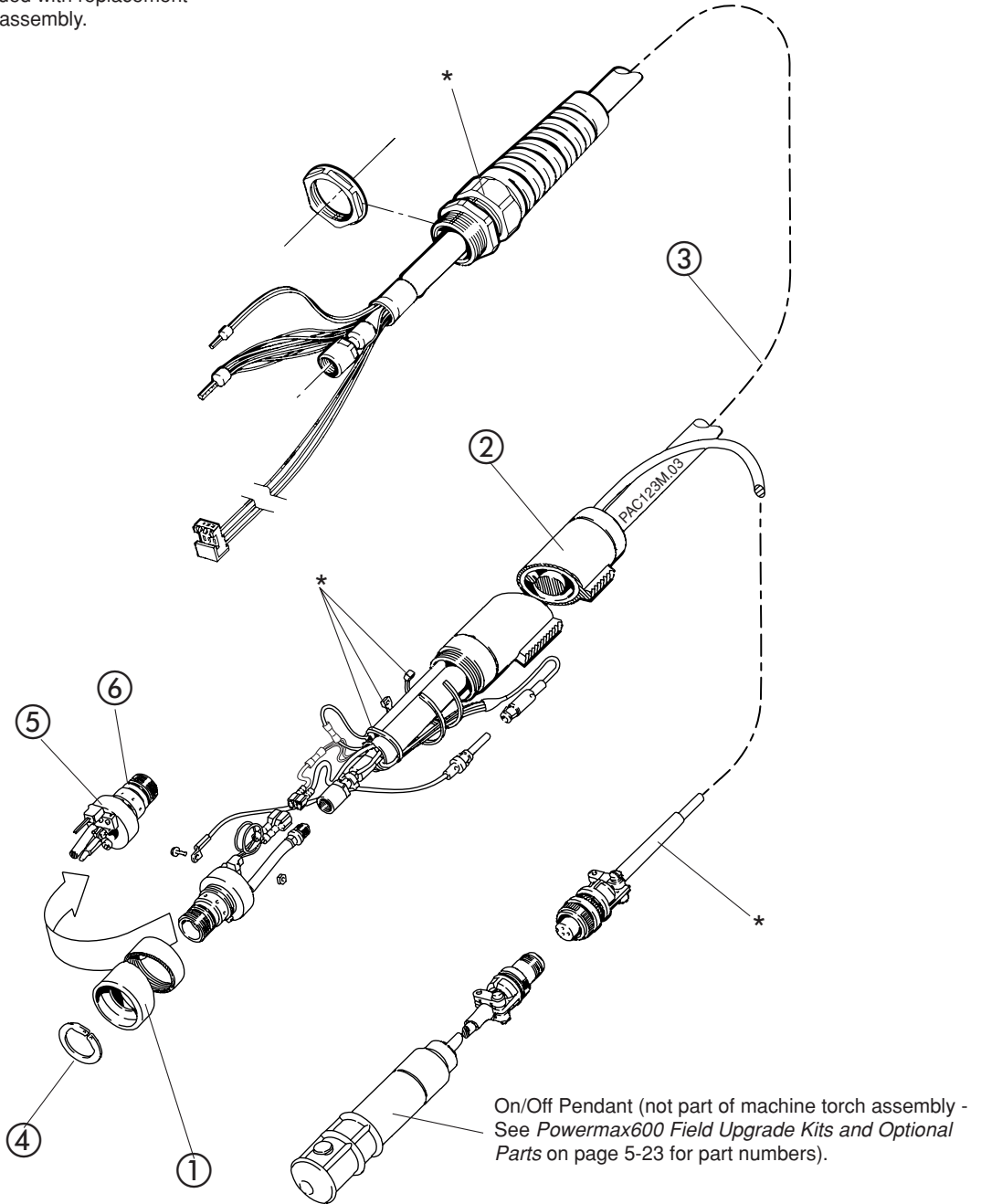

PAC123M Machine Torch and Lead Assembly - No Quick Disconnect

PAC123M Machine Torch Assembly (With Quick Disconnect)

Item	Part Number	Description	Quantity
	086026*	PAC123M Machine Torch Assembly with 15 ft / 4.5 m Lead and Quick Disconnect	
	086027*	PAC123M Machine Torch Assembly with 25 ft / 7.5 m Lead and Quick Disconnect	
	086029*	PAC123M Machine Torch Assembly with 50 ft / 15 m Lead and Quick Disconnect	
1	120613	Sleeve, Machine Torch	1
2	020620	Sleeve, Torch Position	1
3	128572	Replacement Torch Lead w/Quick Disconnect, 15 ft / 4.5 m	1
3	128573	Replacement Torch Lead w/Quick Disconnect, 25 ft / 7.5 m	1
3	128574	Replacement Torch Lead w/Quick Disconnect, 50 ft / 15 m	1
4	027599	Snap Ring	1
5	120583	Torch Main Body with Safety Switch	1
6	044016	O-Ring: BUNA 90 Duro 0.614 X 0.070 inch	1
* Top assembly includes the following consumables (See page 4-3 for details of consumable parts):			
	120573	Electrode	1
	120576	Swirl Ring	1
	120600	Retaining Cap	1
	120826	Nozzle	1
	120827	Shield	1

* Included with replacement lead assembly.

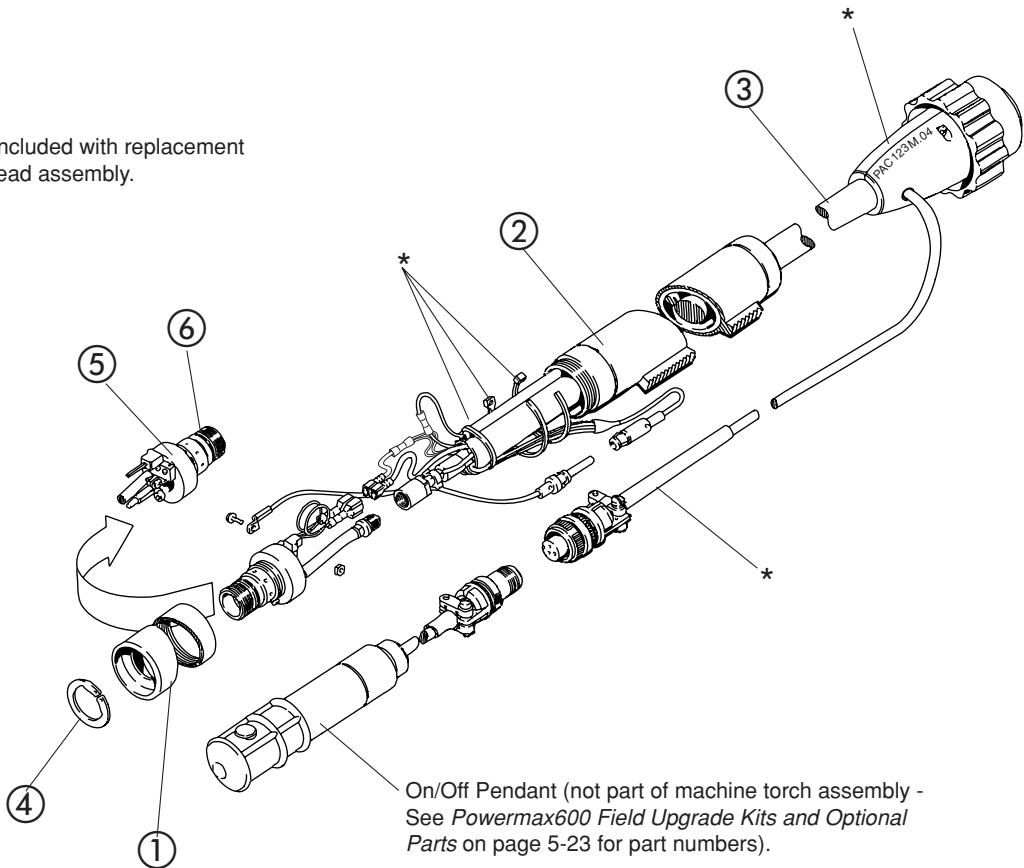

PAC123M Machine Torch and Lead Assembly - With Quick Disconnect

Power Supply – Filter Regulator

Item	Part Number	Description	Qty.
1	011086	Air filter element	1
2	011087	O-ring	1

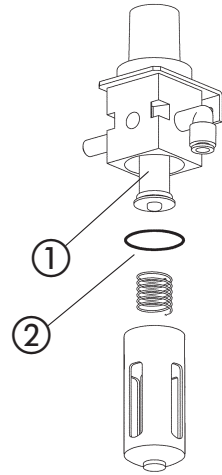

Power Supply – Work Cable

Item	Part Number	Description	Qty.
1	123375	Work Cable with clamp, 15 ft / 4.6 m	1

